



**ALARM LOCK**

345 Bayview Avenue  
Amityville, New York 11701  
For Sales and Repairs 1-800-ALA-LOCK  
For Technical Service 1-800-645-9440

© ALARM LOCK 2007

# Trilogy

## DL4100 / DL4500 Series

### Programming Instructions

WI1194B 10/07



DL4100  
"Privacy Lock"



DL4500  
"Residency Lock"



AL-DTM  
DATA TRANSFER MODULE



DL-Windows



AL-IR1 PRINTER

## Alarm Lock Trilogy Series of Standalone Access Control Systems

# DL SERIES LOCKS

THE **ALARM LOCK** TRILOGY DL-SERIES STAND-ALONE ACCESS CONTROL SYSTEM IS A SERIES OF STATE-OF-THE-ART MICROPROCESSOR-BASED PROGRAMMABLE KEYPAD-ENTRY SECURITY LOCKS.



DL4100

## DL4100 & DL4500

Features a real-time clock/calendar that automatically adjusts for Daylight Saving Time and allows for automated programming of events. Features three methods of programming: (1) all features can be programmed manually through the keypad; (2) you can transfer programming instructions directly from your laptop or desktop PC using DL Windows software and a special *AL-PCI* cable; and (3) data can be transferred from your PC to your DL lock via the AL DTM2 handheld *Data Transfer Module*. In addition, data can be retrieved from the lock in one of three ways (1) through an infrared printer; (2) directly from the lock to the PC; or (3) through an AL-DTM2 to your PC.



DL4500

The DL Series locks include several lock types: but this manual will focus on two: the DL4100 and DL4500. The DL4100 is a cylindrical lock, and the DL4500 is a mortise-based lock, for extra security. Both locks allow use of "Residency" and "Privacy" features, and can be programmed either way to suit the installation requirements. The "Residency" feature is specially designed to prevent unintentional lock-out (typically used in retirement homes and college dormitories), and the "Privacy" feature is designed to deny access to other users after an individual enters (typically used for rooms needing privacy from others such as bathrooms, dorms and meeting rooms). Out of the box (or re-started in order to load the factory default settings), the DL4100 defaults to "Privacy" and the DL4500 defaults to "Residency". See pages 31-32 for more information.

## Table of Contents

<b>DL Series Lock Features.....</b>	<b>3</b>	<b>Programming Functions Overview .....</b>	<b>14</b>
<b>Supported Products .....</b>	<b>4</b>	<b>Programming Functions.....</b>	<b>15-28</b>
<b>Lock Design Overview .....</b>	<b>5</b>	<b>Groups and Scheduled Group 1 Examples .....</b>	<b>29-30</b>
<b>Terminology Used in this Manual.....</b>	<b>6</b>	<b>Residency and Privacy Features.....</b>	<b>31-32</b>
<b>Programming Levels .....</b>	<b>8</b>	<b>Programming Record Sheet.....</b>	<b>33</b>
<b>Conventions Used in this Manual.....</b>	<b>9</b>	<b>User Code Record Sheet .....</b>	<b>34</b>
<b>LED and Sounder Indicators .....</b>	<b>9</b>	<b>Schedule Record Sheet .....</b>	<b>35</b>
<b>Product Communication Examples .....</b>	<b>10</b>	<b>Glossary .....</b>	<b>36</b>
<b>Wiring and Power Up.....</b>	<b>11</b>	<b>Warranty .....</b>	<b>40</b>
<b>Quick Start.....</b>	<b>12</b>		
<b>Testing the Codes Entered .....</b>	<b>13</b>		

# DL Series Lock Features

## Audit Trail

- 40,000 Event Capacity
- Entries Logged with Time and Date
- Critical Programming Events Logged
- Printable using the AL-IR1 Hand-Held Printer (see page 22, Function 55)
- Uploadable using Alarm Lock's DL-Windows software (see page 22, Function 58)
- Transferable to AL-DTMs (see page 23, Function 59)
- 5000 Events with the AL-DTM2

## Lock Features

- Metal Key Override
- Keypad Lockout (see page 23, Functions 60-61)
- Non-Volatile (Fixed) Memory
- Real-Time Clock (within one second accuracy) (see page 20, Functions 43-44)
- Programmable Relay (see page 27)
- Visual and Audible Keypad Feedback (see page 9)
- Battery Status Monitor (see page 9)

## Scheduling

- 500 Schedules with the AL-DTM2 (see pages 25-28)
- Automated Unlock/Lock
- Enable/Disable Users (see page 16, Function 3)
- Enable/Disable Groups (see page 17)
- Four "Quick Schedules" (contains 4 most common schedules) (see page 26)
- Real-time clock and calendar (see page 19)
- Programmable Timeout Functions (see pages 16, 18 and 20)

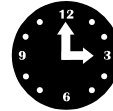

## User Access Methods

- Keypad Entered User Codes (see pages 12, 15)
- Metal Key Override

## User Features

- 2000 Users (see page 15)
- 6 Pre-defined Administration User Levels including *Master*, *Installer*, *Manager*, *Supervisor*, *Print-Only* and *Basic* User Codes (see page 8)
- User Code Lengths from 3-6 digits
- Service Code ("One-Time-Only" Code) (see page 7, 16)
- User Lockout Mode (see page 16, Function 6)
- Users Assignable to 2 Groups (see pages 18 and 29)
- *Ambush* Function (see page 23, Function 66)

## Keypad and Computer Programming

- All programming may be performed manually from the keypad, or from a PC using Alarm Lock's DL-Windows Software (see page 4)



# Supported Products



## Data Transfer Module (AL-DTM)

An **AL-DTM** can be used to transfer Lock Programs (and other data) between DL-Windows and up to 48 locks. When computers cannot be transported or when electrical power is not available, the hand-held **AL-DTM** device acts as a go-between--it allows the transfer of lock data from the computer (through the **AL-DTM**) and to the lock, or in reverse (from the lock through the **AL-DTM** back to the computer).



## AL-DTM2 - Data Transfer Module

The enhanced **AL-DTM2** provides the same functions as the **AL-DTM** but the **AL-DTM2** may be used to transfer program data between a PC running DL-Windows software and up to 96 locks.



## Infrared Printer (AL-IR1)

An **AL-IR1** printer is used to print Audit Trails and User Code lists without the need for a PC. Its infrared reader means no cable connection to the lock is needed.



## AL-PCI Cable

An ALARM LOCK **AL-PCI** cable is required to communicate between your computer's RS-232 serial communications port (COM 1-4) and the **AL-DTM** or lock. One end of the **AL-PCI** cable is designed to be used on a 9-pin serial Com Port. If your computer has a 25-pin Com Port only, a 25-pin to 9-pin adapter must be used. The other end of the **AL-PCI** cable features a 2-pin banana plug connector which is polarity sensitive--the TAB (marked "GND") side must be plugged into the lock's **black** (left) terminal.



## Double-ended Mini Banana Plug Connector

After you create the program in DL-Windows and transfer the program from your computer to an **AL-DTM**, transfer the program from the **AL-DTM** to the lock(s) via a double-ended mini banana plug.



## DB9 to DB9 Serial Cable

Enroll User Codes into DL-Windows, then transfer this new User Code data from the computer to the **AL-PRE** via this 9-pin DB9 to DB9 serial cable. Once the data is in the **AL-PRE**, you can transfer the data to the lock via the double-ended mini banana plug (see above), thus avoiding the need to use an **AL-PCI** cable for this process.



# Lock Design Overview

## Why Use Software inside a Lock?

With ordinary door locks, the need to make physical copies of metal keys and distributing them can be a huge organizational and financial task -- and what will you do if someone causes a security breach by losing their key?

The answer lies in the advantage of SOFTWARE. Software (also called *firmware*) is not "hard" or "fixed" like hardware is. Software is "soft" -- flexible and changeable to your needs. Software exists inside your Alarm Lock™ series lock, and can be programmed (and re-programmed again and again) to suit your changing requirements. No more metal keys to distribute...instead, distribute *User Codes* -- and delete them from the software when needed. (A *User Code* is the software equivalent of a metal key--it is a series of numbers the User enters into the door lock keypad to unlock the lock).

## Preparing to Program your Lock

At first glance, your new DL series lock may look complicated, but it is in fact designed in a very straightforward way. The keypad contains 12 buttons, numbers 1 through 9 plus zero, a star button (  ) and a special "AL" button (  ). These 12 buttons are all you need to program your lock. In addition to manually programming your lock (using only the keypad), you can also program your lock using a computer program called DL-Windows. DL-Windows is not needed--but it makes programming faster and easier. This guide will show you how to program your lock using only the keypad (manually), without DL-Windows. (For more information about DL-Windows, see User Guide OI237).



Programming your lock begins after you unpack it from the box -- there is a specific procedure outlined in "Quick Start" (page 12) in which you "wake up" the lock to prepare it for programming. This "Quick Start" procedure shows you all the steps required to get your lock to start working. To begin programming, you must first enter something called "Program Mode".

## What is Program Mode?

Most technical people find working with "hardware" easy--they use tools to make fixes or changes to hardware. But with the *software* inside the lock, you enact changes (you "interface") through the keypad. The software has only two "modes"--"Normal Mode" and "Program Mode". When you want to make changes to the lock program, you enter "Program Mode". When you finish programming and wish to put the lock into use, you exit Program Mode to enter "Normal Mode".

You enter Program Mode using the keypad--by pressing the *Master Code* of the lock that was set at the factory. The Master Code is basically a secret passcode that allows you to enter Program Mode. But since all locks are identical and leave the factory with the same Master Code, the factory Master Code is therefore not very secret--and should be changed to your own personal Master Code. This way, only YOU can enter Program Mode and make changes to the lock programming.

Once the new Master Code is set, then you can continue with the *Quick Start* procedure and set the weekday, date and time. After this, you can start entering User Codes for people to use. All changes to the lock are organized by their Function Number. Want to change the date? Use Function Number 38. Want to add a User Code? Use Function Number 2. There are 99 Functions in total, some that you will use often, and others that you may never need. **Note:** To prevent possible date and time change-over issues, avoid entering program mode at or near midnight.

Notice that when you program your lock, programming tends to follow a consistent 5-step pattern: (1) Enter Program Mode (2) Press  followed by the Function # (3) Press  and enter data (4) Press  to end (5) Exit Program Mode.

Turn the page and learn about the special terminology used with your lock. Once that is clear, use the Quick Start procedure on page 12 to help you get up and running.

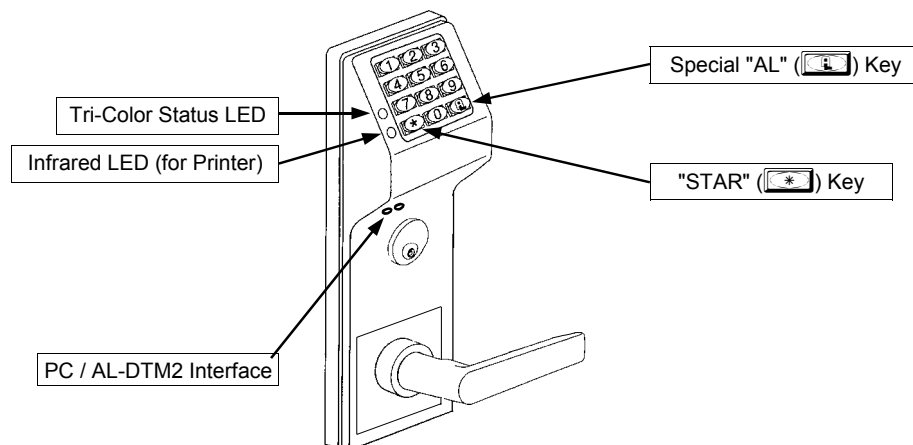

# Terminology Used in this Manual

## What is a Lock Program?

A Lock Program contains the instructions that a lock uses to perform its various functions. You can use the keypad to create a Lock Program stored within the lock. You can also use DL-Windows (defined below) to create a Lock Program on your computer, and then transfer and store the Program in the circuitry contained inside the lock itself. The Lock Program is essentially a computer database file that maintains feature settings, schedules, audit trails, etc. Using DL Windows, Lock Programs can be created with default information, edited on your PC, and then sent to (and even received from) locks.

The **Lock Program** consists of 4 areas: **User Codes**, **Features**, **Time Zones**, and **Schedules**, all defined below:

## What are User Codes?

Also called *User Access Codes* or *PIN No. Codes*, User Codes are numbers the User enters into the lock keypad to unlock the lock. The User Codes are part of the Lock Program, and the Lock Program is stored in the lock circuitry awaiting the Users to key in their User Codes.

## What are Features?

Your lock is designed to support several options and functions. Using the keypad or DL-Windows software (the **Programmable Features** window), you can select the features you wish to activate, such as if the lock will automatically adjust for Daylight Saving Time in the spring and autumn, or if the lock sounder should be disabled or enabled.

## What is a TimeZone?

Events (recorded lock activities) can be programmed to occur at certain times. It is these times (for example, "every Tuesday at 5PM") that are referred to as *TimeZones*. In DL-Windows, you can use the **Schedule-TimeZone** screen to create these TimeZones, and once created, you can link events to these TimeZones.

## What is a Schedule?

Your lock can be programmed to maintain a schedule in which certain events can occur automatically. For example, you can program the lock to allow Groups of Users (with their User Codes) access ONLY during specific business hours. With another example, you can program another lock to UNLOCK at 9am, LOCK at noon for lunch, UNLOCK at 1pm, and LOCK again at 5pm—every weekday. As you can see, many different combinations of Schedules can be created to suit the needs of the Users. First you create *TimeZones* (see above). Next you create events and link them to your TimeZones (also using the **Schedule-TimeZone** screen in DL-Windows). When finished, you can view (in DL-Windows) your schedule in the **Schedule View** screen.

## What is a User?

A User is a person who is authorized to simply use or make certain programming changes to the lock. This User can be anyone—from a one-time visitor (who will almost certainly have no authority to make changes) to the owner of the building in which the lock is installed (who will probably wish to have total authority to make changes). The DL Series locks can hold hundreds of Users in its programming memory, and each User possesses a pre-defined level of authority—a **Programming Level**—as to their ability to use or make changes to the lock.

## What is a Programming Level?

The Programming Level defines the range of programming tasks a User is allowed to perform. The higher the Level, the more programming tasks the User is allowed (with Master allowing ALL tasks).

**Note:** Since the Programming Level is closely associated with the type of User and their abilities, a User who holds a certain Programming Level is sometimes referred to by their "**User Type**".

For example, *DL4500 Series* locks can hold up to 2000 Users in its programming memory, and each User is associated with a User Number (see definition of "User Number" below) and therefore a specific Programming Level, as follows:

**Master:** Always associated with User Number 1. Is always enabled and can program all functions. (Abbreviated as Programming Level = M).

**Installer:** Always associated with User Numbers 2 and 3. Can program all functions except changing the Master Code. (Abbreviated as Programming Level = 4).

**Manager:** Always associated with User Numbers 4, 5, and 6. Can program all functions except functions relating to lock configuration. (Abbreviated as Programming Level = 3).

**Supervisor:** Always associated with User Numbers 7, 8 and 9. Can only program functions relating to day to day operation. (Abbreviated as Programming Level = 2).

**Print Only Users:** Always associated with User Numbers 10 & 11. Restricted to print event logs only. No other programming ability allowed. (Abbreviated as Programming Level = 1).

**Basic Users:** Always associated with User Number 12 and higher (except 297-300). No programming ability allowed. Most Users are *Basic Users*, who are given their own personal User Codes and are only allowed to simply unlock the lock when desired.

Programming Levels are hierarchical—higher levels are allowed to do anything the levels below them can do. For example, if you are a *Manager*, you are allowed to do anything that *Supervisors*, *Print-Only Users* and *Basic Users* can do in addition to those tasks allowed for Managers (Level 3). **See page 8 for more information.**

## What is the Minimum Required Program Level?

This Programming Level abbreviation is the *minimum* programming level required to access the particular Function. (The higher the level number, the more programming tasks the User is allowed, with Master allowing all tasks).

In this manual, Programming Levels for the DL series locks are abbreviated as follows: **M** = Master, **4** = Installer, **3** = Manager, **2** = Supervisor, **1** = Print Only Users. See page 8 for more information.

## What is a User Number?

(*User Number* = *Location Number* = *User Location* = *Slot in Lock*) User Numbers are used and are significant within each individual lock only. The User Number determines the Programming Level for each User. For example, DL4500 Series locks can hold up to 2000 Users in its programming memory. This memory can be thought of as simply a numbered list from 1 through 2000. Each entry in the list is represented by a User Number. Therefore, *where* a User is located in this list—their *User Location*—is a commonly used description of their User Number. Because of their similarities, a *User Number*, *User Location* and *Location Number* can be used interchangeably. In some DL-Windows screens, the

# Terminology Used in this Manual (cont'd)

word "Slot" is also used. They all mean the same thing.

Since User Numbers are fixed, knowing a User Number will specify the associated Programming Level, and will in turn indicate a User's programming abilities. For example, User Number 1 is always the Master, who can perform all programming tasks.

Programming Levels are hierarchical--higher levels are allowed to do anything the levels below them can do. For example, if you are User 2, you are allowed to do anything that Users 3 through 11 can do. See the table on page 8 for more information.

## What is a Group?

With many lock applications, it is convenient for large numbers of similar Users to be grouped together. Placing Users into Groups (by assigning them specific User Numbers) allows large numbers of Users to be controlled all at once rather than individually--saving time and effort. Groups are controlled via schedules, and a typical example involves enabling or disabling a Group at a certain time. Default Group associations are specified in the tables on page 8. For example, if you wish to add a User to Group 1, assign this User a User Number between 51 and 100. These default Group associations can be changed if needed to allow Groups larger than the default number of 50 (by using keypad Function 35). (See page 18 for some Group function examples).

## Who are Users 297-300?

Users assigned to User Numbers 297, 298, 299 and 300 have special abilities, as follows:

### User 297: Quick Enable User 300

User 297 possesses the unique ability to enable the User Code associated with User 300. User 297 does this by first entering their own *User 297 User Code* into the lock keypad. When User 300 subsequently enters their *User 300 User Code*, the lock allows access (for one time) and then the *User 300 User Code* becomes disabled.

For example, you wish to allow one-time access to a temporary worker. Simply enter the *User 297 User Code* into the lock keypad. Later, when the temporary worker enters the *User 300 User Code* into the lock keypad, the *User 300 User Code* allows access (for one time only) and then becomes disabled. Later, if you wish to grant the temporary worker re-access, simply re-enter the *User 297 User Code* and the *User 300 User Code* will be re-enabled (again for one time only).

### User 298: Quick PC Access Code

Entering the User Code for User 298 enables that User to send data to or from the lock. Therefore, User 298 can activate what is the equivalent of Function 58 in Program Mode (see page 22), without the need to enter Program Mode nor the need to know the Master Code of the lock. An AL-PCI cable with a PC is required.

### User 299: AL-DTM Code

This is the only User Code that will initiate data transfer with the AL-DTM--and without allowing the User to pass through the door

(the User Code for User 299 is not an Access Code). An AL-PCI cable and an AL-DTM (first programmed by the computer via the *DTM* or *DTM2* screen in DL-Windows) is required.

### User 300: Temporary Access Service Code ("One-Time Only")

Temporary access User Code enabled by User 297. For example, User Code 300 is sometimes used for guard tour duties. See *User 297: Quick Enable User 300* above.

## What is DL-Windows?

DL-Windows is a computer program that allows you to program your ALARM LOCK T3 Security Lock. You do not need DL-Windows to program your lock, but it makes programming much faster and easier. With DL-Windows, you can quickly create Lock Programs (programs that make the lock perform its many functions) add multiple Users (who have access), retrieve event logs, and create Schedules. The benefit of DL-Windows is that it allows you to set up all lock programming in advance (on your computer), and then later send the information to the locks at your convenience.

# Programming Levels

The Programming Level defines the range of programming tasks a User is allowed to perform. The higher the Level, the more programming tasks the User is allowed (with Master allowing ALL tasks).

**Note:** Since the Programming Level is closely associated with the type of User and their abilities, a User who holds a certain Programming Level is sometimes referred to by their "User Type".

For example, DL Series locks can hold hundreds of Users in its programming memory, and each User is associated with a User Number (see definition of "User Number" in the previous "Terminology" section) and therefore a specific Programming Level, as follows:

**Master:** Always associated with User number 1. Is always enabled and can program all functions. (Abbreviated as Programming Level = M).

**Installer:** Always associated with Users 2 and 3. Can program all functions except changing the Master Code. (Abbreviated

as Programming Level = 4).

**Manager:** Always associated with Users 4, 5, and 6. Can program all functions except functions relating to lock configuration. (Abbreviated as Programming Level = 3).

**Supervisor:** Always associated with Users 7, 8 and 9. Can only program functions relating to day to day operation. (Abbreviated as Programming Level = 2).

**Print Only Users:** Always associated with Users 10 & 11. Restricted to print audit trails only. No other programming ability allowed. (Abbreviated as Programming Level = 1).

**Basic Users:** Always associated with User number 12 and higher (except 297-300). No programming ability allowed.

Programming Levels are hierarchical--higher levels are allowed to do anything the levels below them can do. For example, if you are a *Manager*, you are allowed to do anything that *Supervisors*, *Print-Only Users* and *Basic Users* can do in addition to those tasks allowed for Managers (Level 3).

Lock Defaults for the DL4100 and DL4500			
Users added will default to a Group Association and a Program Level Ability as follows:			
USER TYPE	USER NUMBER	GROUP DEFAULT ASSOCIATION	MINIMUM PROGRAM LEVEL (See page 6)
Master Code	1	-	M (All Programming Abilities)
Installer Codes	2 & 3	none	4 (Also 3, 2, 1)
Manager Codes	4 - 6	none	3 (Also 2, 1)
Supervisor Codes	7 - 9	none	2 (Also 1)
Print Only Codes	10 - 11	none	1
Basic User Codes	12 - 50	none	none
Basic User Codes Group 1	51 - 100	1	none
Basic User Codes Group 2	101 - 150	2	none
Basic User Codes Group 3	151 - 200	3	none
Basic User Codes Group 4	201 - 250	4	none
Basic User Codes	251 - 296	none	none
Quick Enable User 300 Code	297	none	none
Quick PC Access Code	298	none	none
AL-DTM Code	299	none	none
Service Code	300	none	none
Basic User Codes	301-2000	none	none

**NOTES:**

User 299 is a Non-Pass Code. This is the only code that will initiate data transfer with the AL-DTM.



# Conventions Used in this Manual

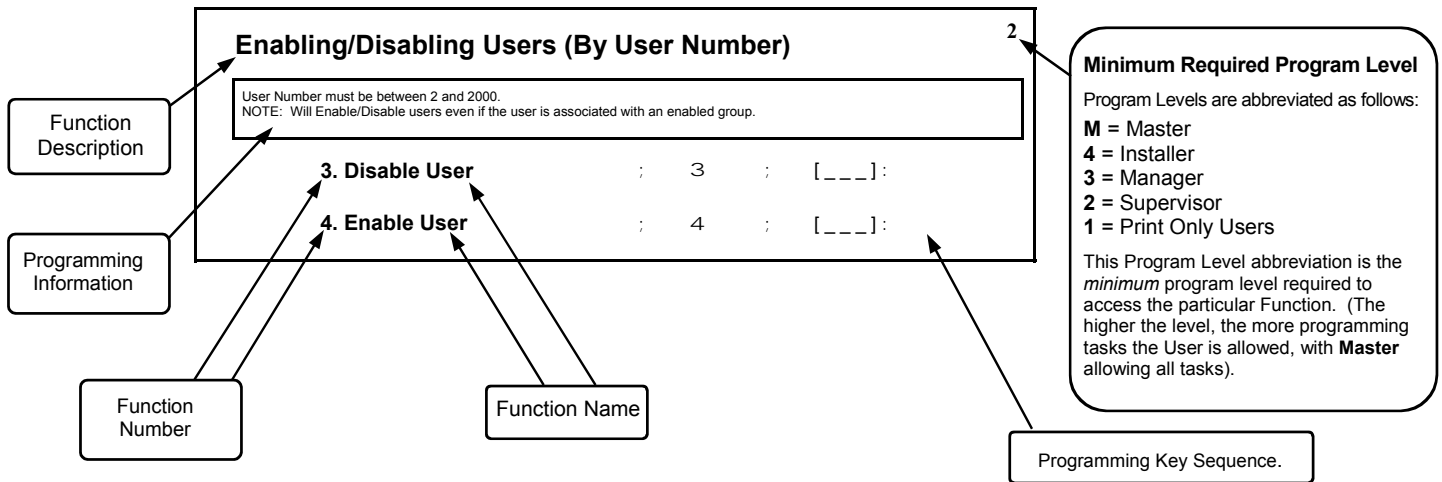

## General Program Mode Information

If a wrong key is pressed during code entry, hold any key continuously until the error sound is heard (7 short beeps), this will clear the entry. Re-enter the key sequence again.

All program sequences are followed by the : key; 2 short beeps indicate a successful program sequence.

# LED and Sounder Indicators

The DL Series locks provide visual and audible keypad feedback. With a fully charged battery, the LED and sounder feedback is as follows:

ACTIVITY	LED	SOUNDER	COMMENTS
Keypress	1 RED Flash	1 Beep	Normal Operation
Access Granted	3 GREEN Flashes	3 Beeps	
Invalid Code	6 RED Flashes	6 Beeps	Re-enter User Code
Successful Program Entry	2 GREEN Flashes	2 Beeps	When in Program Mode
Unsuccessful Program Entry	7 RED Flashes	7 Beeps	When in Program Mode
Exit Program Mode	Flashes: 1 Red, 2 Green, then 1 Red	10 Beeps	"73" in Continuous Wave ( <i>Morse Code</i> )
Valid but Disabled Code	1 Green, 4 Red Flashes	1 long, 5 short beeps	Code exists in memory, but disabled
Low Battery	Yellow Flash during key presses	Long Beep	See page 11 before changing batteries
User Code Entered	Yellow Flash	Sequence of 7 Beeps Repeated 4 Times	Non-fatal memory or clock error has been detected. Under this condition, unexpected operation is possible. Remove power and restart.
Inside Lever Depressed and held down	7 Red Flashes, 1 Red Flash	7 Beeps. 1 Beep	Example: Inside lever not released for 5 seconds after User Code access granted.
Outside Lever Depressed and held down	7 Red Flashes, 2 Red Flashes	7 Beeps. 2 Beeps	Example. Outside lever depressed for 5 seconds after User Code access denied.
Deadbolt Engaged / Button Pressed and button held down	7 Red Flashes, 3 Red Flashes	7 Beeps. 3 Beeps	Example: Valid User Code entered while Deadbolt extended.

## Product Communication Examples

Send to lock

Receive from lock

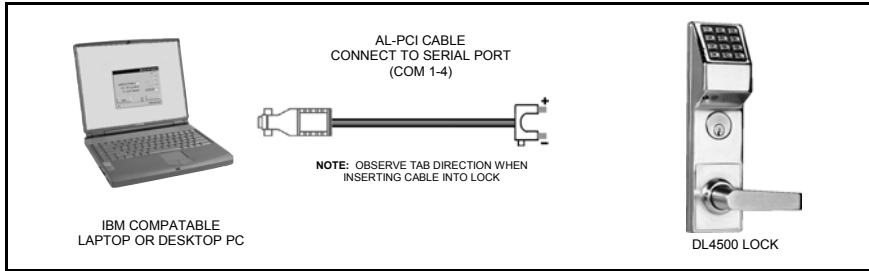

If your computer does not have a serial COM port (DB-9 male) available, you can plug your AL-PCI2 cable into a special USB to RS-232 cable. Order part **MX1130** for the USB to RS-232 cable only, or **ALPCI2-U** for both the USB to RS-232 cable and an AL-PCI2 cable.



**Scenario 1** Create the program in DL-Windows on your computer, then transfer the program from the computer directly to the lock via an AL-PCI cable. You must always enter the User 298 User Code to send or receive data Using DL-Windows.

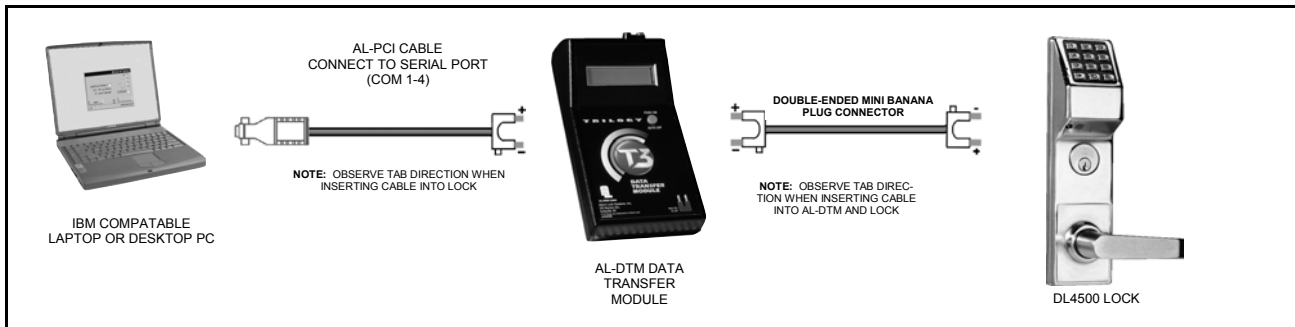

**Scenario 2** Create the program in DL-Windows and transfer the program from your computer to an AL-DTM (via an AL-PCI cable)... then transfer the program from the AL-DTM to the lock(s) (via a double-ended mini banana plug). The hand-held AL-DTM is useful because you do not have to transport (or find electricity for) your computer. Data can also flow in reverse, from the lock, through the AL-DTM, back to the computer for examination.

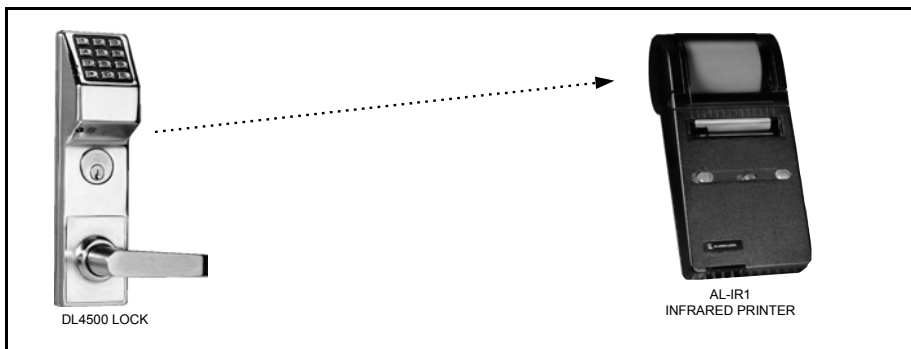

**Scenario 3** Use the AL-IR1 Infrared printer to print your lock's audit trail (event log), User Code list, clock settings and software version. No cable required.

### NOTE:

The AL-PCI cable is designed to be used on a 9 pin serial COM port. If your computer has a 25 pin COM port, a 25 pin to 9 pin adapter must be used.

**Warning:** Polarity **MUST** be observed when connecting cables to the lock. The tab (-) must plug into the negative (black) hole.

# Wiring and Power Up

## WIRING

See the Installation Manual for more information.

### Batteries:

Use only 1.5 volt Alkaline size-AA batteries.

### External Power:

Red / Black wires - External 7.5 VDC Power Source must be used for operation without batteries in the lock. Use an external UL-Listed power supply provided with backup battery power and current limiting protection that is approved for the application.

### Relay:

COM-Blue / NO-Yellow / NC-Green - See page 24 (Function 67) for programming options for the Relay.

## Wiring to Disarm a Burglary Control Panel

Burglary Control Panel wiring. See page 27.



## POWER UP

- **When applying power to the lock for the first time**, stop and follow the procedure outlined in "Quick Start, First time Power Up" further in this manual.
- **When power is re-applied to a lock that was already operational**, proceed as follows:
  1. Disconnect battery pack connector.
  2. With battery power disconnected, press **and hold down**  for 10 seconds to insure discharge of all capacitors.
  3. Re-connect battery pack (lock will sound 3 short beeps). If beeps are not heard, then restart at step 1.
  4. **Do not press any keys for 15 seconds.**
  5. After 15 seconds, the LED will flash red 6 times and 6 beeps will sound.

The lock is now ready for use. The pre-existing program is loaded from fixed memory. Set the clock using functions 38, 39 and 40.

## ERASE ALL PROGRAMMING

(The "out of box" factory default will be loaded)

1. Remove the battery pack.
2. With battery power disconnected, press **and hold down**  for 10 seconds to ensure discharge of all capacitors.
3. Re-install the battery pack (lock will sound 3 short beeps). If beeps are not heard, then restart at step 1.
4. Within 5 seconds after hearing the 3 short beeps, press and hold  until the lock begins to beep, then release.
5. A series of 5 RED LED and 5 beeps will be heard followed

by 10 seconds of silence, then 3 GREEN LEDs and 3 fast beeps.

All settings and programming have been erased and the lock is now ready for use. **Note:** All lock programming can also be erased (without need to disconnect the batteries) by entering Function 99.

## BATTERY REPLACEMENT



When a valid code is entered and the batteries are weak, the yellow LED will light and the sounder will sound for 4 seconds. DL Series locks use five (5) AA-size 1.5 volt alkaline batteries. Always replace weak batteries as soon as possible.

**CAUTION: Do not press any keys while batteries are disconnected or you may erase the real-time clock settings.**







1. At the back of the lock, remove the screw at the bottom of the lock housing and remove the cover.
2. Pull out the battery pack and quickly replace all 5 batteries - within 1 minute.
3. If you **do not** hear the 3 beeps when power is re-applied, all programming and settings have been retained, and the lock is ready for use. Go to step 5.
4. If you **do** hear 3 beeps when power is re-applied, **do not press any keys for 15 seconds.** After the 15 second period, the LED will flash red 6 times and 6 beeps will sound. Reset the clock using functions 38, 39 and 40.
5. Replace the cover and tighten the screw.

# Quick Start

## First Time Start Up

1. Unpack the lock.
2. With the batteries disconnected, hold down the  key for 10 seconds and release.
3. Connect the batteries and listen for 3 beeps. Within 5 seconds of hearing the 3 beeps, press and hold  until beeping starts. This will clear the lock of all programmed data. Important: If you do not hear these 3 beeps, you must start over at step 2.
4. Listen for another series of beeps and LED flashes *followed by 10 seconds of silence*. The lock is now ready to program. Failure to follow this exact procedure can result in erratic lock behavior. **Important Note:** When entering any key sequence below, *do not pause more than 25 seconds between any key presses*--otherwise you must start again.

## Enter Program Mode and Change Factory Master Code

















1. Press the default Master Code:      .
2. Wait for the green light and press  until multiple beeps are heard. You are now in Program Mode.



**Note:** The lock will beep every 6 seconds as a reminder that you are in Program Mode.

3. Enter a new personal 6-digit Master Code number by pressing the following keys:

   [new Master Code]  [new Master Code]  (the second set of digits must be exactly the same).

(For example, if you want your new Master Code to be "664433". Press:











                .

Now that the Master Code has been changed, there is no need to change it again (unless you want to). Since you are still in Program Mode, you can now proceed directly below and program various functions. **Note:** Programming any Function, such as setting the clock, follows a consistent 5-step pattern: (1) Enter Program Mode (2) Press  [Function #] (3) Press  and enter data (4) Press  to end (5) Exit Program Mode.

















**Note:** There is a 3 minute Program Mode timeout if no keys are pressed when in Program Mode. A steady tone will sound for the final 15 seconds of the 3 minute timeout period as a warning. To remain in Program Mode, press any key.

**Note:** To prevent possible date and time changeover issues, avoid entering program mode at or near midnight.















## Set the Weekday

1. Enter Program Mode (if not in already).
2. Press     [number of weekday] . (Use 1= Sunday, 7 = Saturday).  
(For example - Friday - press      .



















## Set the Date

1. Enter Program Mode (if not in already).
  2. Press     [MMDDYY] .
- (For example - May 10, 2002 - press           .

## Set the Time

1. Enter Program Mode (if not in already. If you just finished the above procedure, you are still in Program Mode).
  2. Press     [HHMM] .
- (For example - 2:30pm - press         .

## Enter User Codes

1. Enter Program Mode (if not in already).
  2. Press    [User Number]  [new User Code] .
- (For example, John Smith is designated as User 21. You want him to use the code of "232323" to unlock the door. Program the lock by pressing:             .
3. Repeat step 2 for each new user.

## Delete a User Code

1. Enter Program Mode (if not in already).

## Quick Start (cont'd)

2. Press    [User Number] .

The lock will flash a green LED and beep continuously for 6 seconds. When the red LED flashes, the User Code is deleted.

3. Repeat step 2 for each new User.

### User Code Conflicts

Care should be taken not to program a new User Code which matches the first digits of any other User Code (only the User Code with the least number of digits will be recognized). **Example:** If User Codes 123 and 123456 are both entered in the system, only code 123 would be recognized, unless the ENTER Key has been enabled (see Function 69, see page 25). In addition, an error will sound if you try to program a new User Code that matches the first digits of the Master Code.

**WARNING: When attempting to change an existing Master Code, it is HIGHLY recommended that you enable all Groups (see Function 23), exit Program Mode, and enter the new anticipated Master Code to verify that the anticipated sequence does not currently open the lock. If the lock does not open, the anticipated Master Code can be used as the new Master Code; if the lock opens, the anticipated Master Code already exists in the lock (as a User Code), and the anticipated Mater Code should NOT be used. Always repeat this procedure with any new anticipated Master Codes.**

### Exit Program Mode

Hold Down any key for 3 seconds. Program Mode exit is confirmed by several beeps. You are now in normal operation.

### Re-enter Program Mode

If you wish to re-enter Program Mode, key-in your new 6-digit Master Code, and press .

You are now ready to mount and install your DL series lock and give out your User Codes. Before installation, it is suggested you test and verify that all User Codes entered are active (see below).

## Testing the Codes Entered

### Verifying Basic Keypad User Codes

Test a valid User Code:

**VALID CODE** - The Green LED will flash momentarily and the sounder will beep a few times after a valid code is entered.

**INVALID CODE** - The RED LED will flash several times and the sounder will beep several times after an invalid code is entered.

Use Function 2 to re-program the code.

# Programming Functions--Overview

Function 1	Change Master Code	See page 15
Function 2	Add/Delete/Change User Codes	See page 15
Function 3	User Disable (By User Number)	See page 16
Function 4	User Enable (By User Number)	See page 16
Function 5	User Enable with Timeout	See page 16
Function 6	Enable Total User Lockout	See page 16
Function 7	Disable Total User Lockout	See page 16
Function 8	Reserved	---
Function 9	Enable User 300 (Service Code)	See page 16
Function 10	Erase All Users Except the Master Code	See page 16
Function 11	Reserved	---
Function 12	Clear All Schedules and Timeout Functions	See page 17
Function 13	Clear All Timeout Functions	See page 17
Function 14 - 17	Group 1-4 Disable	See page 17
Function 18	Disable All Groups	See page 17
Function 19 - 22	Group 1-4 Enable	See page 17
Function 23	Enable All Groups	See page 17
Function 24	Reserved	---
Function 25 - 28	Group Disable with Timeout	See page 18
Function 29	Disable All Groups with Timeout	See page 18
Function 30 - 33	Group Enable with Timeout	See page 18
Function 34	Disable All Groups with Timeout	See page 18
Function 35	Group Add/Delete Association	See page 18
Function 36 - 37	Reserved	---
Function 38	Set Date	See page 19
Function 39	Set Time	See page 19
Function 40	Set Weekday	See page 19
Function 41	Set Daylight Savings Time	See page 19
Function 42	Reserved	---
Function 43	Speed Up Clock	See page 20
Function 44	Slow Down Clock	See page 20
Function 45 - 46	Passage Mode Enable/Disable	See page 20
Function 47	Timed Passage Mode	See page 20

Function 48	Enable Permanent Passage Mode	See page 21
Function 49	Disable Permanent Passage Mode	See page 21
Function 50	Return Lock to Normal Passage Mode Schedule	See page 21
Function 51	Passage Mode Configuration	See page 21
Function 52 - 54	Pass Time	See page 21
Function 55	Print Audit Trail	See page 22
Function 56	Print User Code List	See page 22
Function 57	Print Clock Settings and Software Version	See page 22
Function 58	Upload/Download PC Data	See page 22
Function 59	AL-DTM2 Door Number	See page 23
Function 60	Number of Attempt Before Lockout	See page 23
Function 61	Set the Attempts Lockout Time	See page 23
Function 62 - 63	Reserved	---
Function 64 - 65	Reserved	---
Function 66	Ambush Code	See page 23
Function 67	Add Relay/System Features	See page 24
Function 68	Delete All Relay Functions and System Options added by Function 67. Also Privacy Time-out duration.	See page 24
Function 69 - 70	Enable/Disable Enter Key	See page 25
Function 71	Reserved	---
Function 72 - 73	Scheduled Enable/Disable Passage Mode	See page 25
Function 74 - 77	Schedule Enable Group 1 - 4	See page 25
Function 78	Schedule Enable All Groups	See page 25
Function 79 - 82	Schedule Disable Group 1 - 4	See page 25
Function 83	Schedule Disable All Groups	See page 25
Function 84 - 87	Quick Schedules - Enable Group	See page 26
Function 88	Passage Mode (Open Time Window)	See page 26
Function 89	Passage Mode (Close Time Window)	See page 26
Function 90	Relay Activation (Open Time Window)	See page 27
Function 91	Relay Activation (Close Time Window)	See page 27
Function 92	Enable Group 4 (Open Time Window)	See page 28
Function 93	Enable Group 4 (Close Time Window)	See page 28
Function 94 - 98	Reserved	---
Function 99	Clear All Lock Programming	See page 28

# Programming Functions

## USERS

**1. New Master Code** (User Number 1) ; 1 ; [\_\_\_\_\_] ; [\_\_\_\_\_] :  
 (New Master Code) (Confirm New Master Code)

- Master Code must be 6 digits-only. **M**
- Master Code is Keypad Code Access only.
- **Factory Default** =
- See "Lock Design Overview" on page 5 for more information about Master Codes.

**2. Add/Delete/Change User Codes 2-2000** ; 2 ; [\_\_\_\_\_] \* ; [\_\_\_\_\_] :  
 (User Number) (User Code)

- User Number must be between 2 and 2000. **3**
- To delete a code/card, leave the User Code blank and wait for the rapid beeping to stop.
- User Code must be 3-6 digits.
- Each User Code can be thought of as a person. As long as each person possesses their own unique User Code, you can control access to the lock by adding or deleting User Codes. See "Terminology Used in this Manual" on page 6 for more information.

### Lock Defaults for the DL4100 and DL4500

See page 8. Users added will default to a Group Association and a Program Level Ability as follows:

USER TYPE	USER NUMBER	GROUP DEFAULT	MINIMUM PROGRAM
Master	1	-	<b>M</b> (All Programming Abilities)
Installers	2 & 3	none	<b>4</b> (Also 3, 2, 1)
Managers	4 - 6	none	<b>3</b> (Also 2, 1)
Supervisors	7 - 9	none	<b>2</b> (Also 1)
Print Only Users	10 - 11	none	<b>1</b>
Basic Users	12 - 50	none	none
Basic Users in Group 1	51 - 100	1	none
Basic Users in Group 2	101 - 150	2	none
Basic Users in Group 3	151 - 200	3	none
Basic Users in Group 4	201 - 250	4	none
Basic Users	251 - 296	none	none
Quick Enable User 300	297	none	none
Quick PC Access	298	none	none
AL-DTM2 Code	299	none	none
Service User	300	none	none
Basic Users	301-2000	none	none

User 299 is a Non-Pass Code. This is the only code that will initiate data transfer with the AL-DTM.

# Programming Functions (cont'd)

## USERS (Continued)

### User Enable/Disable (By User Number)

- User Number must be between 2 and 2000. 2
- NOTE:** Will Enable/Disable Users even if the User is associated with an enabled Group. Use Feature 3 to disable a specific User Number and their associated User Code. If the disabled User Code is entered, the lock will flash 1 Green and 4 Red Flashes (with 1 long and 5 short beeps) indicating that the User Code exists in memory, but is disabled. Function 4 will "undo" Function 3.

**3. Disable User** ; 3 ; [ \_\_\_\_ ] :  
(User Number)

**4. Enable User** ; 4 ; [ \_\_\_\_ ] :  
(User Number)

**5. User Enable with Timeout** ; 5 ; [ \_\_\_\_ ] ; [ \_\_\_\_ ] :  
(Enter Timeout, XXX Hours) (User Number) (XXX Hours)  
*(This Function enabled through keypad only)*

- With Function 5, User Numbers must be between 2-2000, hours must be between 1-999. 2
- Function 5 can temporarily override a disabled User (disabled using Function 3 above).
- Since this is a temporary feature, Function 5 can only be enabled using the keypad.
- **Example:** Brian, User Number 1157, rarely works at the office, but when he does, enable him for his 8 hour work day by entering Program Mode and pressing: 
- **NOTE:** Up to 4 Timeout Functions may be pending at any one time. An error beep will sound when attempting to program more than 4 Timeout Functions.

### User Lockout Mode

Prevents all User Codes (Except User 1 Code) from operating the lock. **Note:** No other programming functions or schedules will re-enable Users. Users must be re-enabled with Function 7. M  
**Note:** Does not change the User enable/disable status. **Note:** If the lock is currently in Passage Mode (door "unlocked") and Function 6 is programmed, the lock will remain in Passage Mode.

**6. Enable Total User Lockout Mode** ; 6 :  
*(This Function enabled through keypad only)*  
**Note:** Do not use this function with Passage Mode.

**7. Disable Total User Lockout Mode** ; 7 :  
*(This Function enabled through keypad only)*

### 8. Reserved

**9. Enable User 300** (Service Code) ; 9 :

- Service Code is a One-Time-Only Code. Once it is used, it is disabled until enabled again. 2  
**NOTE:** User Number 297 is used to reset Service Code Use. See "Terminology Used in this Manual" on page 7 for more information and examples regarding special Users 297-300.

**10. Erase All Users Except the Master Code** (User 1) ; 1 0 ; 0 0 0 :  
*(This Function enabled through keypad only)*

- Erases all User Codes except the Master Code (User 1). M  
• Function 10 can only be performed using the keypad.

### 11. Reserved



# Programming Functions (cont'd)

## CLEAR FUNCTIONS

### 12. Clear All Schedules and Timeout Functions ; 1 2 ; 0 0 0 :

Function 12 clears all programmed *Schedules* and all *Timeout Functions*. (To clear All Timeout Functions only, see Function 13 below). Function 12 will clear all of the following: All Schedule Functions 72 through 93, Timeout Functions 5, 25 through 34 and Function 47. **Note:** Function 12 also resets Passage Mode and any disabled Groups. After using Function 12, your Scheduled/Timeout features must be manually re-programmed. **NOTE:** Up to 4 Timeout Functions may be pending at any one time. An error beep will sound when attempting to program more than 4 Timeout Functions. 3

### 13. Clear All Timeout Functions ; 1 3 ; 0 0 0 : (This Function enabled through keypad only)

Function 13 clears all *Timeout Functions*. (To clear All Schedules and Timeout Functions, see Function 12 above). Function 13 will clear all of the following: All Timeout Functions 5, 25-34 and Function 47. After using Function 12, your Scheduled/Timeout features must be manually re-programmed. **NOTE:** Up to 4 Timeout Functions may be pending at any one time. An error beep will sound when attempting to program more than 4 Timeout Functions. 3

**Important:** It is the responsibility of the lock programmer to verify the proper lock/unlock conditions and Group conditions after programming the lock with Function 12 and 13.

## GROUPS

### Group Enable/Disable

Enter the functions below to Enable/Disable Groups. Functions 14 - 23 will each override existing scheduled events. Therefore, Functions 14 - 23 are temporary, take effect immediately, and are always overridden by future scheduled events that already exist within the lock programming. 2

- 14. Disable Group 1 ; 1 4 :
- 15. Disable Group 2 ; 1 5 :
- 16. Disable Group 3 ; 1 6 :
- 17. Disable Group 4 ; 1 7 :
- 18. Disable All Groups ; 1 8 :
- 19. Enable Group 1 ; 1 9 :
- 20. Enable Group 2 ; 2 0 :
- 21. Enable Group 3 ; 2 1 :
- 22. Enable Group 4 ; 2 2 :
- 23. Enable All Groups ; 2 3 :

### PRIORITY ORDER

1. Disabled Users
2. Enabled Groups
3. Disabled Groups
4. Enabled Users

The Priority Order details which Function will take effect before ("have priority over") others. For example, as per the list above, Enabled Users have the lowest priority, and other Functions can affect the status of these Users. Disabling a Group (Functions 14-18) will take priority over the enabled Users in that Group, disabling them. Enabling Groups (Functions 19-23) will take priority over those tasks lower in the list, and finally disabling a User (Function 3) takes priority over all other tasks listed.

### 24. Reserved

# Programming Functions (cont'd)

## GROUPS

**NOTE:** Clear All Timeout Functions by entering Function 13.

### Group Enable/Disable with Timeout (Enter Timeout, XXX Hours)

(Functions 25-34 are enabled through the keypad only)

- Hours must be between 1-999. Enter the functions below to Enable/Disable Groups for the amount of time entered in hours. 2  
**NOTE:** Only 4 Timeout Functions are allowed at any one time. An error beep will sound when attempting to program more than 4 Timeout Functions. Functions 25 - 34 will each override existing scheduled events. Therefore, Functions 25 - 34 are temporary, take effect immediately, and are always overridden by future scheduled events that already exist within the lock programming. **NOTE:** Functions 25-34 are enabled through the keypad only.
- Example:** All 15 members of the Accounting Department are members of Group 4, and a schedule programmed in the department's door lock reflects their normal working hours of 9 AM through 5 PM, Monday through Friday. But one day a special event occurs, and all Accounting Department members are requested to stay an extra hour until 6 PM. Therefore, at 5 PM, the manager (wishing to temporarily enable Group 4 users for an extra hour) enters Program Mode and presses: **1** **3** **3** **1** **0** **0** **1** **\***. Likewise, if the manager wished to send his department home early at 3 PM, the manager could enter **1** **2** **8** **1** **0** **0** **2** **\***.

25. Timed Disable Group 1 ; 2 5 ; [ \_ \_ \_ ] :  
(XXX Hours)

26. Timed Disable Group 2 ; 2 6 ; [ \_ \_ \_ ] :  
(XXX Hours)

27. Timed Disable Group 3 ; 2 7 ; [ \_ \_ \_ ] :  
(XXX Hours)

28. Timed Disable Group 4 ; 2 8 ; [ \_ \_ \_ ] :  
(XXX Hours)

29. Timed Disable All Groups ; 2 9 ; [ \_ \_ \_ ] :  
(XXX Hours)

30. Timed Enable Group 1 ; 3 0 ; [ \_ \_ \_ ] :  
(XXX Hours)

31. Timed Enable Group 2 ; 3 1 ; [ \_ \_ \_ ] :  
(XXX Hours)

32. Timed Enable Group 3 ; 3 2 ; [ \_ \_ \_ ] :  
(XXX Hours)

33. Timed Enable Group 4 ; 3 3 ; [ \_ \_ \_ ] :  
(XXX Hours)

34. Timed Enable All Groups ; 3 4 ; [ \_ \_ \_ ] :  
(XXX Hours)

35. Group Add/Delete Association ; 3 5 ; [ \_ \_ \_ ] ; [ \_ \_ \_ \_ ] :  
(User Number) (Groups)

As per the chart on page 8, the lock's default programming from the factory associates certain User Numbers with certain Groups. To override these default Group associations, Function 35 manually associates (or disassociates) a selected User with a selected Group. During programming, Groups not selected are then disassociated from the User. Function 35 is helpful when the number of Users you wish to add to a Group outgrows the number of User Numbers defaulted to a Group (50); or if an existing User joins a department and you wish to simply add them to a Group.

- User Number must be between 2 and 2000; Groups 1-4 (to associate with User) may be selected.

**Add Example:** To associate User 67 with Groups 1, 2 and 4;

Enter: ; 3 5 ; 6 7 ; 1 2 4 ;

**Delete Example:** To remove all Group associations for User 67;

Enter: ; 3 5 ; 6 7 ;

**NOTE:** If a User is associated with more than one Group, all associated Groups would have to be disabled before the User is disabled.

### 36 - 37. Reserved

# Programming Functions (cont'd)

## CLOCK SETTINGS

### 38. Set Date

; 3 8 ; [ \_ \_ \_ \_ ] :  
(Date)

- Use Month Day Year format - MMDDYY - Single digit months and days are entered with a preceding zero.
- Enter ONLY the last two digits of the year.

3

**For Example:** March 8, 2002;

Enter:

; 3 8 ; 0 3 0 8 0 2 :

### 39. Set Time

; 3 9 ; [ \_ \_ \_ ] :  
(Time)

- Time must be 4 digits
- Use 24 Hour Format (add 12 hours to program PM time).

3

**For Example:** To set time to 8:25 PM;

Enter: ; 3 9 ; 2 0 2 5 :

**For Example:** To set time to 8:25 AM;

Enter: ; 3 9 ; 0 8 2 5 :

### 40. Set Weekday

; 4 0 ; [ \_ ] :  
(Day)

- For day enter: 1 for Sunday, 2 for Monday, 3 for Tuesday, 4 for Wednesday, 5 for Thursday, 6 for Friday and 7 for Saturday.

3

**For Example:** To set day to Sunday;

Enter: ; 4 0 ; 1 :

### 41. Set Daylight Saving Time

; 4 1 ; [ \_ \_ ] :  
(DST Mode)

**NOTE:** Daylight Saving Time (DST) adjustment is programmable as shown in the table below. All modes adjust time at 2AM. \* Default DST Mode is 12.

4

DST Mode	Time Forwarded	Time Regressed
01	No DST Adjustment	
02	1st Sunday in March	4th Tuesday in Sept.
03	Last Sat. in March	Last Sat. in Sept.
04	Last Sunday in March	Last Sunday in Sept.
05	Last Sunday in March	4th Sunday in Oct.
06	Last Sunday in March	Last Sunday in Oct.
07	Last Sunday in March	1st Sunday in Sept.
08	April 1st	September 30th
09	April 1st	October 1st
10	April 1st	Last Sunday in Oct.
11	1st Sunday in April	2nd Sunday in Oct.
* 12 (U.S.A. & Canada)	1st Sunday in April	Last Sunday in Oct.

DST Mode	Time Forwarded	Time Regressed
13	Last Friday in April	Last Thurs. in Sept.
14	May 1st	September 30th
15	1st Sunday in Sept.	1st Sunday in April
16	2nd Tuesday in Sept.	3rd Tuesday in April
17	1st Sunday in Oct.	Last Sunday in Feb.
18	1st Sunday in Oct.	3rd Sunday in March
19	1st Sunday in Oct.	Last Sunday in Mar.
20	2nd Sunday in Oct.	2nd Sunday in Mar.
21	3rd Sunday in Oct.	2nd Sunday in Feb.
22	Last Sunday in Oct.	1st Sunday in March
23	Last Sunday in Oct.	Last Sunday in Mar.
24	1st Sunday in Nov.	Last Sunday in Feb.

### 42. Reserved

# Programming Functions (cont'd)

## CLOCK ADJUST

### Clock Adjust

Number of seconds to adjust (speed up/slow down) the clock each day must be between 0-55 seconds. 4

Always consider the current setting when using this function, because this function is not cumulative. For example, if the clock needs to be sped up 10 seconds per day and the current setting is already 10, program 20 seconds using Function 43 (below).

**Example 1:** Clock is losing 13 seconds every day, enter:

; 4 3 ; 1 3 :

This example assumes that the Clock Adjust setting was at the factory default of zero. Function 57 can be used to print the current Clock Adjust setting.

**Example 2:** Clock is gaining 13 seconds every day, enter:

; 4 4 ; 1 3 :

This example assumes that the Clock Adjust setting was at the factory default of zero. Function 57 can be used to print the current Clock Adjust setting.

**Example 3:** To set the clock adjust setting back to the factory default of zero, enter:

; 4 3 : or ; 4 4 :

**NOTE:** Subsequent use of these functions are not cumulative.

**43. Speed Up Clock** ; 4 3 ; [ \_ \_ ] :  
(This Function enabled through keypad only) (seconds)

**44. Slow Down Clock** ; 4 4 ; [ \_ \_ ] :  
(This Function enabled through keypad only) (seconds)

## PASSAGE MODE

### Passage Mode Enable/Disable - Schedule will Override

- Function 45 allows passage through the door without the need for a User Code. Re-Lock using Function 46. 2
- Programmed Schedules will override the state of the lock when Functions 45 and 46 are used. If it is required that programmed schedules do not override Passage Mode, enable/disable Passage Mode using Functions 48/49. **Note:** Because of the temporary nature of these features, Functions 45-47 can only be enabled using the keypad.

**45. Enable Passage Mode** ; 4 5 :  
(This Function enabled through keypad only)

**46. Disable Passage Mode** ; 4 6 :  
(This Function enabled through keypad only)

**47. Timed Passage Mode** ; 4 7 ; [ \_ \_ \_ ] :  
(This Function enabled through keypad only) (XXX Hours)

- Hours must be between 1 - 999. 2
- Function 47 allows passage through the door without the need for a User Code for the programmed amount of time.
- For example, if you wish your office door lock to be unlocked (unlocked = "Passage Mode") for the next 3 hours, enter Program Mode and press: 

# Programming Functions (cont'd)

## PERMANENT PASSAGE MODE

### Passage Mode Enable/Disable - Schedule will not Override

- Function 48 allows passage through the door without the need for a User Code. Re-Lock using Function 49. 2
- Programmed Schedules will not override the state of the lock using functions 48 and 49. If it is required that programmed schedules override Passage Mode, Enable/Disable Passage Mode using Functions 45/46. Use Function 50 to "undo" Functions 48 and/or 49, and therefore return the lock to all pre-existing scheduled functions. **Note:** Functions 48-50 can only be enabled using the keypad. **Warning:** Function 49 will inhibit all scheduled Passage Mode events.

**48. Enable Permanent Passage Mode** ; 4 8 ;  
(This Function enabled through keypad only)

**49. Disable Permanent Passage Mode** ; 4 9 ;  
(This Function enabled through keypad only)

**50. Return Lock to Normal Passage Mode Schedule** ; 5 0 ;

(This Function enabled through keypad only)

(Locks will lock or unlock depending on the current schedule). Use Function 50 to "undo" Functions 48 and/or 49, and therefore return the lock to all pre-existing scheduled functions.

**NOTE:** See Scheduled functions 72 and 73 for Scheduled Passage Mode.

**51. Passage Mode Configuration** ; 5 1 ; [ ] ;  
(Mode)

- **Mode 1 (Normal):** Passage Mode must be enabled/disabled using Function 45 and 46. **Mode 1 (Normal) is the factory default.**
- **Mode 2:** Group 2 toggles Passage Mode. **Because of firmware conflicts, do not use this function with the Residency Feature, nor with the Privacy Feature Mode 2 "Door Normally Unlocked".**
- **Mode 3:** Group 2 enables, Group 3 disables Passage Mode. Disable Passage Mode has priority if User is a member of both Groups 2 and 3. **Because of firmware conflicts, do not use this function with the Residency Feature nor with the Privacy Feature Mode 2 "Door Normally Unlocked".**

With **Mode 2**, each time any member of Group 2 enters their User Code, they will toggle Passage Mode. For example, if Passage Mode is enabled, and a Group 2 User enters their User Code, Passage Mode will be disabled. If a few seconds later they enter their User Code again, Passage Mode will be enabled. With **Mode 3**, Group 2 members will always enable Passage Mode, and Group 3 members will always disable Passage Mode. For example, if Passage Mode is already enabled, and a Group 2 User enters their User Code, the Passage Mode status will not be changed due to the Function 51 Mode 3 configuration. If Passage Mode is already enabled, and a Group 3 User enters their User Code, Passage Mode will become disabled.

## PASS TIME

### Pass Time

The Pass Time is the length of time the lock stays unlocked after a valid User Code is entered. When the Pass Time expires, the lock will re-lock automatically. Use the functions below to change the Pass Time to 3, 10 or 15 seconds. **The Pass Time is defaulted to 3 seconds.** 4

**52. Set Pass Time to 3 Sec.** ; 5 2 ;

**53. Set Pass Time to 10 Sec.** ; 5 3 ;

**54. Set Pass Time to 15 Sec.** ; 5 4 ;

# Programming Functions (cont'd)

## PRINTER

Hold the printer perpendicular to the Lock's infrared LED as shown in Figure 1 and Figure 2. If the printer has been idle for some time, press the paper feed button to wake up the printer.

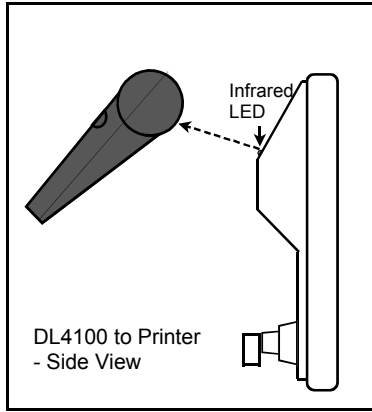

Figure 1

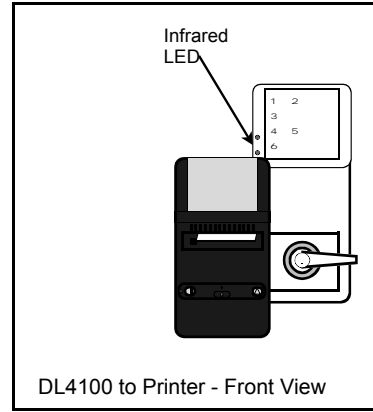

Figure 2

### 55. Print Audit Trail ; 5 5 :

Hold the printer over the lock's infrared sensor as shown in Figure 1 and Figure 2 above. Twenty (20) events will print at a time; press 1 for more events, or 9 to quit. To abort printing, press any key for 3 seconds (three short beeps will sound).

1

### 56. Print User Code List ; 5 6 :

Hold the printer over the lock's infrared sensor as shown in Figure 1 and Figure 2 above. To abort printing, press any key for 3 seconds (three short beeps will sound).

3

### 57. Print Clock Settings, Software Version and Door Number ; 5 7 :

Hold the printer over the lock's infrared sensor as shown in Figure 1 and Figure 2 above.

1

## DOWNLOADING

### 58. Upload/Download PC Data ; 5 8 :

For use with DL-WINDOWS software, refer to OI237. AL-PCI interface cable is needed.

3

# Programming Functions (cont'd)

## AL-DTM2

### 59. AL-DTM2 Door Number

; 5 9 ; [ \_ \_ ] :  
(Door Number)

- Door Number must be between 1-96. **Note:** Door Number must be between 1-48 for AL-DTM (Version 1). **Factory default is 01.**

4

Function 59 is for use with Alarm Lock's AL-DTM2 Data Transfer Module. Using the AL-DTM2, up to 96 locks can be Downloaded/Uploaded and History Logs can be retrieved. Enter a door number for each lock. After configuring the AL-DTM2, using Alarm Lock's DL-WINDOWS Software, any of the following data transfers can be initiated by plugging the AL-DTM2 into the lock and simply entering the User Code for User 299 at the lock.

- Upload Lock Program
- Upload History Log
- Download Lock Program

## LOCKOUT

### 60. Number of Attempts Before Lockout

; 6 0 ; [ \_ ] :  
(Number of Attempts)

Used with Function 61

- Number of attempts before lockout must be 1-9 attempts.
- The number of attempts is reduced by half every time the keypad is locked out without a successful code entry (default is 6 attempts).
- The attempt count is reset each time a valid code is entered.

4

### 61. Set the Attempts Lockout Time

; 6 1 ; [ \_ \_ ] :  
(Lockout Time)

Function 61 determines the length of time the keypad is locked-out after a series of unsuccessful attempts (default is 18 seconds). Used with Function 60.

- Lockout Time must be 1-60 seconds.

4

### 62-65. Reserved

## AMBUSH

### 66. Ambush Code

; 6 6 ; [ \_ \_ ] :  
(Ambush Code)

- Ambush code must be 2 digits.
- An error will sound if the Ambush Code matches the 1st two digits of any User Code. See Function 67 for more information about the Ambush Function.
- **Factory default Ambush Code is 99.**

3

# Programming Functions (cont'd)

## SYSTEM FEATURES

### 67. Add System Features

; 6 7 ; [ \_ \_ ] :  
(Event Number)

#### • Relay Features (12-24. Reserved)

4

Use Function 67 to program **one or more** lock events and the Relay will energize when the programmed event(s) listed below occurs. For example, program ; 6 7 ; 3 : and when an attempted entry fails (such as a User who enters an incorrect or un-programmed User Code), the Relay will energize for 2 seconds.

3. <b>Failed attempted entry.</b> Relay energizes for 2 seconds when an attempted User Code entry via the keypad fails.	8. <b>Scheduled Unlock Event.</b> Relay energizes for 2 seconds when lock is unlocked by a schedule
4. <b>Disabled User or Group.</b> Relay energizes for 2 seconds when a disabled User or disabled Group member enters a User Code.	9. <b>Lock Out.</b> Relay energizes for 2 seconds when a Lock Out occurs (i.e. number of attempts is exceeded, see Function 60).
5. <b>Follow Access Granted.</b> When a valid User Code is entered into the keypad and the lock unlocks, the Relay energizes for 2 seconds. Compare with Event 31.	10. <b>Ambush.</b> Relay energizes for 2 seconds when Ambush is tripped. See Function 66, page 25.
6. <b>Group 1 User Code.</b> Relay energizes for 2 seconds when a scheduled Group 1 User Code is entered. See Function 90, page 29.	11. <b>First Key Press.</b> Relay energizes for 2 seconds at the first key press of any sequence.
7. <b>Scheduled Lock Event.</b> Relay energizes for 2 seconds when lock is locked by a Schedule.	31. <b>Follow Access Granted—No Time Limit.**</b> When a valid User Code is entered into the keypad and the lock unlocks, the Relay energizes for the <i>same amount of time as the programmed Pass Time</i> . (The Pass Time is the length of time the lock stays unlocked after a valid User Code is entered. See functions 52-54). Use this feature for remote monitoring or other activation.

#### • Privacy/Residency Features

35. Disable Keypad on Deadbolt (DL4500) or Button Press (DL4100). (Often used for bathroom doors).
36. Cancel Passage on Deadbolt (DL4500) or Button Press (DL4100)
37. Leave Unlocked on Exit (Passage)

#### • System Options

25. Disable Sounder
26. 5 sec. Delayed Entry *
27. 15 sec. Delayed Entry *
28. 45 sec. Delayed Entry *

\* Features 26, 27 & 28 will delay User Codes 12 and higher only (except 297, 298 and 299).

\*\* Feature 31 should be used with External DC Power unless feature is used for short a duration and infrequently (sustained closure of relay will drain batteries).

**NOTE:** Enter ; 6 7 ; 0 0 0 : to delete all Relay Features added by Function 67 (identical to Function 68).

#### Ambush Function

1. Connect relay to a device able to properly monitor dry contacts for an *Ambush* condition.
2. Program the Relay for *Ambush Tripped* using Program Function 67(10) above.
3. Set the Ambush Code using Program Function 66.
4. When the Ambush Code is entered followed by a valid User Code, the relay will close for 2 seconds.

**Notes:** The Ambush Code defaults to **99**. An error will sound if you try to program a new User Code starting with the Ambush Code.

### 68. Delete All Relay Functions and System Options added by Function 67. Also Privacy Time-Out Duration.

; 6 8 ; [ \_ \_ \_ ] :  
(3-digits)

Enter ; 6 8 ; 0 0 0 : to delete all Relay Functions and System Options added by Function 67. **Note:** Programming "000" does not affect existing "Privacy Time-Out Duration" settings, described below.

When using a DL4100 or DL4500, enter a number between 001-250 for Privacy Time-Out Duration, in minutes (be sure to enter 3 digits). This Privacy Time-Out Duration is the maximum time lock will remain in Privacy Mode, before returning to standard operation (defaulted to 10 minutes).

#### Privacy Terminated on Exit Only

Enter 251 to *disable the Privacy Time-Out Duration*: Privacy will last indefinitely until either the inside lever is turned or until a Master or valid Manager User Code is entered at the keypad. In addition, the flashing LED is disabled.

**Note:** Existing "Privacy Time-Out Duration" settings are not affected by subsequent programming of "000" (which is used to delete all relay functions and system options added by Function 67).

**Note:** The factory default is set to "Residency Feature" for the DL4500 and "Privacy Feature" for the DL4100. Entering ; 6 8 ; 0 0 0 : will clear the factory default of the lock. To re-program factory default, see page 11.

**Note:** To maintain backwards compatibility, entering ; 6 7 ; 0 0 0 : or entering ; 6 8 ; 0 0 0 : will delete all Relay Functions and System Options added by Function 67.

4



# Programming Functions (cont'd)

## ENTER KEY

### Enter Key

- When this function is enabled, the User must press : after any valid User Code entry. Therefore, this Function allows User Codes to be subsets of other User Codes. 4

Examples:

- 1 2 3 : can be a valid user code;
- 1 2 3 4 : can be a valid user code within the same lock.
- 1 2 3 4 5 6 : (Hold ; ) for Master User Code to enter Program Mode.

**69. Enable :** as Enter Key ; 6 9 :

**70. Disable :** as Enter Key ; 7 0 :

**71. Reserved**

## SCHEDULES

**NOTE:** Clear All Schedule and Timeout Functions by entering Function 12. To set the time, see Function 39.

### Scheduled Passage and Group

Use the functions below to enable Passage Mode and enable/disable Groups at the time programmed. 3

- For day enter: 1 for Sunday, 2 for Monday, 3 for Tuesday, 4 for Wednesday, 5 for Thursday, 6 for Friday, 7 for Saturday, 8 for Monday to Friday, 9 for Saturday and Sunday, and 0 for all days of week.

**Passage Mode**      **72. Schedule Enable Passage Mode ("Unlock")** ; 7 2 ; [ \_ ] ; [ \_\_\_\_ ] :  
(Day) (Time)

**73. Schedule Disable Passage Mode ("Lock")** ; 7 3 ; [ \_ ] ; [ \_\_\_\_ ] :  
(Day) (Time)

**Groups**      **74. Schedule Enable Group 1** ; 7 4 ; [ \_ ] ; [ \_\_\_\_ ] :  
(Day) (Time)

**75. Schedule Enable Group 2** ; 7 5 ; [ \_ ] ; [ \_\_\_\_ ] :  
(Day) (Time)

**76. Schedule Enable Group 3** ; 7 6 ; [ \_ ] ; [ \_\_\_\_ ] :  
(Day) (Time)

**77. Schedule Enable Group 4** ; 7 7 ; [ \_ ] ; [ \_\_\_\_ ] :  
(Day) (Time)

**78. Schedule Enable All Groups** ; 7 8 ; [ \_ ] ; [ \_\_\_\_ ] :  
(Day) (Time)

**79. Schedule Disable Group 1** ; 7 9 ; [ \_ ] ; [ \_\_\_\_ ] :  
(Day) (Time)

**80. Schedule Disable Group 2** ; 8 0 ; [ \_ ] ; [ \_\_\_\_ ] :  
(Day) (Time)

**81. Schedule Disable Group 3** ; 8 1 ; [ \_ ] ; [ \_\_\_\_ ] :  
(Day) (Time)

**82. Schedule Disable Group 4** ; 8 2 ; [ \_ ] ; [ \_\_\_\_ ] :  
(Day) (Time)

**83. Schedule Disable All Groups** ; 8 3 ; [ \_ ] ; [ \_\_\_\_ ] :  
(Day) (Time)

# Programming Functions (cont'd)

## QUICK SCHEDULES

### Quick Schedules - Enable Group

For your convenience, your lock comes pre-programmed with Quick Schedules, which, when programmed, enable Groups for popular blocks of time. Group members will be enabled during the blocks of time defined below, but will still need to enter their User Codes into the keypad to unlock the lock.

3

- Group number must be 1-4; enter the number of the Group that is to be enabled for the time specified by the Quick Schedules below.

**Note:** These Quick Schedules can **only** be programmed through the keypad (not through DL-Windows), and existing Quick Schedules **will be over-written** by schedules downloaded from DL-Windows. Therefore, after downloading any DL-Windows schedules, be sure to re-program your Quick Schedules into your Lock Program.

**84. Business Quick Schedule** ; 8 4 ; [\_] :  
7AM-5PM, Monday - Friday (Group)  
*(This Function enabled through keypad only)*

**85. Day Quick Schedule** ; 8 5 ; [\_] :  
7AM-5PM, All days (Group)  
*(This Function enabled through keypad only)*

**86. Evening Quick Schedule** ; 8 6 ; [\_] :  
3PM-1AM, All days (Group)  
*(This Function enabled through keypad only)*

**87. Night Quick Schedule** ; 8 7 ; [\_] :  
11PM-9AM, All days (Group)  
*(This Function enabled through keypad only)*

## SCHEDULES GROUP 1 ACTIVATED

### Scheduled Passage Mode (Group 1 Activated)

Functions 88 and 89 allow you to set up a window of time where if any **Group 1** User Code is entered within this window, Passage Mode will be activated, allowing anyone to enter. **Note:** This feature can only be programmed using the lock keypad. For additional information, see Group 1 Activated Features on page 30.

3

- For the **day** enter: 1 for Sunday, 2 for Monday, 3 for Tuesday, 4 for Wednesday, 5 for Thursday, 6 for Friday, 7 for Saturday, 8 for Monday to Friday, 9 for Saturday and Sunday, and 0 for all days of week.
- Enter time of day in 24 hour format (for example, for 2:15 PM, enter 14:15).

**Note:** Because of firmware conflicts, do not use this function with the Residency Feature nor with the Privacy Feature Mode 2 "Door Normally Unlocked".

**88. Passage Mode** ; 8 8 ; [\_] ; [\_\_\_\_] :  
(Open Time Window) (Day) (Time)  
*(This Function enabled through keypad only)*

**89. Passage Mode** ; 8 9 ; [\_] ; [\_\_\_\_] :  
(Close Time Window) (Day) (Time)  
*(This Function enabled through keypad only)*

# Programming Functions (cont'd)

## SCHEDULES GROUP 1 ACTIVATED

### Scheduled Relay Activation (Group 1 Activated)

Functions 90 and 91 allow you to set up a window of time where if any **Group 1** User Code is entered within this window, the relay will be activated for 2 seconds. This relay is for use with a Control Panel that has a key switch disarm option. For additional information, see Group 1 Activated Features on page 30.

3

- Also program Relay Function 6 using Function 67 (: 6 7 : 6 : ).
- For **day** enter: 1 for Sunday, 2 for Monday, 3 for Tuesday, 4 for Wednesday, 5 for Thursday, 6 for Friday, 7 for Saturday, 8 for Monday to Friday, 9 for Saturday and Sunday, and 0 for all days of week.
- Enter time of day in 24 hour format (for example, for 2:15 PM, enter 14:15).

**90. Relay Activation** ; 9 0 ; [ \_ ] ; [ \_ \_ \_ \_ ] :  
 (Open Time Window) (Day) (Time)

**91. Relay Activation** ; 9 1 ; [ \_ ] ; [ \_ \_ \_ \_ ] :  
 (Close Time Window) (Day) (Time)

### To Disarm a Burglary Control Panel

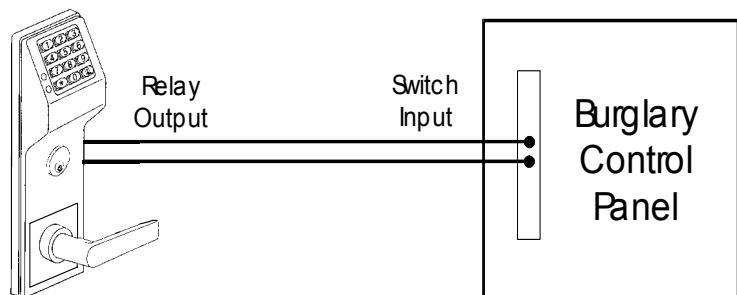

Alarm Panel with Switched Input for Disarming

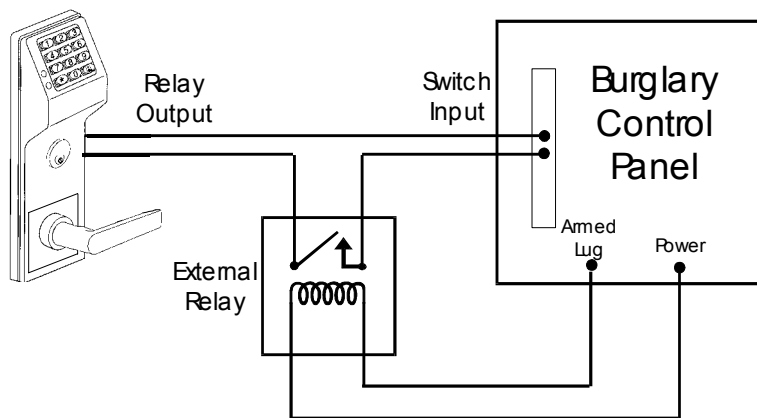

Alarm Panel with Switched Input for Toggled Arm/Disarm

### NOTES

1. **Group 1 Disarms a Burglary Control Panel** will always disarm an alarm system. Arming should be performed by other means (such as Alarm Panel Keypad/Schedule).
2. Use a qualified electrical/alarm specialist to review your current alarm system and add additional components as needed (such as a relay, wire, resistors, connectors and/or diodes) and re-program the operation of your alarm system as needed.

# Programming Functions (cont'd)

## Scheduled Group 4 Enable (Group 1 Activated)

Functions 92 and 93 allow you to set up a window of time where if any **Group 1** User Code is entered within this window, Group 4 members will be enabled. (Group 4 members will still need to enter their User Codes to enter). For additional information, see Group 1 Activated Features on page 30.

3

- For **day** enter: 1 for Sunday, 2 for Monday, 3 for Tuesday, 4 for Wednesday, 5 for Thursday, 6 for Friday, 7 for Saturday, 8 for Monday to Friday, 9 for Saturday and Sunday, and 0 for all days of week.
- Enter time of day in 24 hour format (for example, for 2:15 PM, enter 14:15).

**92. Enable Group 4** ; 9 2 ; [\_] ; [\_\_\_\_]:  
(Open Time Window) (Day) (Time)  
*(This Function enabled through keypad only)*

**93. Enable Group 4** ; 9 3 ; [\_] ; [\_\_\_\_]:  
(Close Time Window) (Day) (Time)  
*(This Function enabled through keypad only)*

**94 - 98. Reserved**

### CLEAR ALL PROGRAMMING

**99. Clear All Lock Programming** ; 9 9 ; 0 0 0 :  
*(This Function enabled through keypad only)*

Clears all programming, and returns lock to factory default settings ("Residency" for DL4500 and "Privacy" for DL4100). Audit Trail contents are maintained.

**M**

**Note:** See Function 68 on page 24 for clearing "Residency" and "Privacy" Features.

# Groups and Scheduled Group 1 Examples

The following examples detail the more advanced features of the DL series locks. Although all features and device functions can be programmed using the lock keypad, when programming becomes more complex you may find it easier to use DL-Windows software to program your Alarm Lock security lock. For more information, contact your Alarm Lock security professional.

## Assign a User to Two Groups

Create a User 101 (all Users 101-150 are members of Group 2 by default) and include User 101 in Group 3 (as well as the default Group 2).

1. Enter Program Mode (if not in already).
2. Using Function 2, create User 101 with a User Code of "789":  
Press .
3. Using Function 35, make User 101 a member of Group 2 and 3:  
Press .
4. Exit Program Mode.

**Note:** See step 3 above--although User 101 is by default a member of Group 2, you must include Group 2 when using Function 35 or the Group 2 association will be removed.

The example to add Users to Group 2 and Group 3 has been selected due to the fact that *Group 1 Activated Functions* require that a member of Group 1 enter their User Code to activate the Function, and it may become necessary to assign Users to Groups.

## Group 1 Activated Features: Functions 88/89, 90/91 and 92/93

- **Function 88 and 89** allow for a window of time to be created where if any Group 1 User Code is entered within the programmed window, *Passage Mode* will be activated (the device physically unlocks, allowing passage for all). If a Group 1 User does not enter their User Code during the specified window, Functions 88/89 remain inactive. **Note: Because of firmware conflicts, do not use this function with the Residency Feature nor with the Privacy Feature Mode 2 "Door Normally Unlocked".**
- **Function 90 and 91** allow for a window of time to be created where if any Group 1 User Code is entered within the programmed window, a *relay* will be activated for 2 seconds. This relay can be used with a burglar alarm control panel that has a key switch disarm option. See **To Disarm a Burglary Control Panel** on page 27. If a Group 1 User does not enter their User Code during the specified window, Functions 90/91 remain inactive.
- **Function 92 and 93** allow for a window of time to be created where if any Group 1 User Code is entered within the programmed window, the *User Codes in Group 4* will be enabled. If a Group 1 User does not enter their User Code during the specified window, Functions 92/93 remain inactive. Companies typically use this feature to allow Group 1 Managers the ability to enable all Group 4 staff members during a certain window of time.

The following examples illustrate how Functions 88-93 can be programmed into your DL Series lock via the keypad:

**Functions 88/89:** Use Function 88 to set an *Open Time Window* (during which the Group 1 User must enter their User Code), and then use Function 89 to set the time to close the Window. Re-lock the door at night manually (Function 46) or program the lock to disable Group 4 Users (Function 82). **Note: Because of firmware conflicts, do not use this function with the Residency Feature nor with the Privacy Feature Mode 2 "Door Normally Unlocked".**

1. Enter Program Mode (if not in already).
2. Using Function 2, create User 4 with a User Code of "456789":  
Press .
3. Because User 4 does not have a default Group association, make User 4 a member of Group 1 using Function 35:  
Press .
4. Use Function 88 and Function 89 (see page 26) to designate Passage Mode as being between the hours of 8:30 A.M. and 10 A.M. for all days of the week:  
**Function 88** (Open Window Time) = 8:30 A.M.: Press ; 8 8 ; 0 ; 0 8 3 0 :  
**Function 89** (Close Window Time) = 10:00 A.M.: Press ; 8 9 ; 0 ; 1 0 0 0 :  
5. Exit Program Mode (hold down any key for 3 seconds).

The lock will now be put in Passage Mode (device physically unlocked) if User 4 (or any Group 1 member) enters their User Code between 8:30 A.M. and 10 A.M. If a Group 1 User does not enter their User Code during the specified window, Functions 88/89 remain inactive

- The device will have to be manually locked each night by entering the following command using Function 46:  
; 4 6 :
- The device can also be programmed to automatically lock (disable Passage Mode) each night at 5 P.M. by using Function 73:  
; ; 0 ; 1 7 0 0 :
- Remember to exit Program Mode when programming is complete.

# Groups and Scheduled Group 1 Examples (cont'd.)

**Functions 90/91:** Use Function 90 and 91 (see page 27) to create a window of time where if any Group 1 User Code is entered within the programmed window, a relay will be activated for 2 seconds. The relay can be configured to disarm a burglary control panel. See page 28.

1. Enter Program Mode (if not in already).
2. Connect relay to a burglar control panel with switch input for disarming.
3. Using Function 2, create User 4 with a User Code of "456789":  
Press 2 4 4 5 6 7 8 9 .
4. Because User 4 does not have a default Group association, make User 4 a member of Group 1 using Function 35:  
Press 3 5 4 1 .
5. Use Function 90 to set the time to open the window (8:30 A.M. all days of the week) allowing any Group 1 member to close the relay for 2 seconds. **Note:** Only 1 relay closure will occur even if another member of Group 1 enters their User Code. Use Function 91 to set the time to close the window (10 A.M. for all days of the week):  
**Function 90** (Open Window Time) = 8:30 A.M.: Press ; 9 0 ; 0 ; 0 8 3 0 :  
**Function 91** (Close Window Time) = 10:00 A.M.: Press ; 9 1 ; 0 ; 1 0 0 0 :
6. Exit Program Mode (hold down any key for 3 seconds).

The relay will close, one time only, when a member of Group 1 enters their User Code between 8:30AM and 10:00AM. If a Group 1 User does not enter their User Code during the specified window, Functions 90/91 remain inactive

- The alarm panel will have to be armed at night by the User or by an automatic schedule function of the alarm panel.

**Functions 92/93:** Use Function 92 and 93 (see page 28) to create a window of time where if any Group 1 User Code is entered within the programmed window, *Group 4 Users* will be enabled.

1. Enter Program Mode (if not in already).
2. Using Function 2, create User 4 with a User Code of "456789":  
Press 2 4 4 5 6 7 8 9 .
3. Because User 4 does not have a default Group association, make User 4 a member of Group 1 using Function 35:  
Press 3 5 4 1 .
4. Using Function 17, disable Group 4. (Group 4 will need to be "disabled" before it can be "enabled" later).  
Press 1 7 .
5. Use Function 92 to set the time to open the window (8:30 A.M. all days of the week) allowing any Group 1 member to enable Group 4. Use Function 93 to set the time to close the window (10:00 A.M. all days of the week).  
**Function 92** (Open Window Time) = 8:30 A.M.: Press ; 9 2 ; 0 ; 0 8 3 0 :  
**Function 93** (Close Window Time) = 10:00 A.M.: Press ; 9 3 ; 0 ; 1 0 0 0 :
6. Exit Program Mode (hold down any key for 3 seconds).

The lock will now enable Group 4 User Codes if User 4 (or any Group 1 member) enters their User Code between 8:30 A.M. and 10 A.M. If no Group 1 member arrives to enter their User Code between 8:30 A.M. and 10 A.M., Group 4 User Codes will not be enabled and will remain disabled all day.

- The device will have to be manually locked each night by entering the following command using Function 82:  
; 4 6 :
- The device can also be programmed to automatically disable Group 4 members each night at 5 P.M. by using Function 82:  
; 8 2 ; 0 ; 1 7 0 0 :
- Test the device by creating User 222 (with User Code 466466) and adding User 222 to Group 4:  
; 2 ; 2 2 2 ; 4 6 6 4 6 6 :  
; 3 5 ; 2 2 2 ; 4 :
- Remember to exit Program Mode when programming is complete.

# DL4500 Residency and Privacy Features

## Residency Feature (Factory Default)

The "Residency Feature" is provided to prevent a person from unintentionally having the door lock behind them when stepping outside briefly. Typically used in retirement homes and college dormitories.

Configuring the DL4500 for the "Residency Feature" will initially provide a normally locked state. To enter through a DL4500 monitored door the user must use an access code or key. The DL4500 will then re-lock when door is closed. Turning the handle and exiting from the inside will unlock the DL4500 and set it to passage mode.

Any of the following will restore the lock to the normally secure mode.

1. The user returns, enters, and throws the deadbolt from the inside.
2. Someone already inside the premises throws the deadbolt.
3. Pre-programmed scheduling.
4. Entering a valid access code, or locking with a key.

**Programming: Leave Unlocked on Exit (Passage)**

**Cancel Passage on Deadbolt**

\*\*\*\*\*

## Privacy Feature Mode 1: (Door Normally Locked) Programmable Through DL-Windows and Keypad

"Privacy Feature Mode 1" is designed to allow access to individuals with access codes and is typically used for rooms needing privacy from others such as bathrooms, dorms and meeting rooms.

Configuring the DL4500 for the "Privacy Feature Mode 1" will initially provide a normally locked state. To enter through a DL4500 monitored door the user must use an access code or key. Once inside, the user throws the deadbolt and automatically disables the keypad from allowing another user to enter for a pre-programmed amount of time. The red LED on the exterior / outside of the lock will blink indicating that the room is occupied. When the initial user exits, the DL4500 is automatically set back into the original locked mode and allows access to any authorized users.

The disable time (lockout) for the DL4500 can be pre-programmed by the installer. The disable time can be programmed to disable access code access for up to 250 minutes. All users 12 and higher are disabled when this feature is active. Users 1 - 11 or a key can always override this lockout feature with their codes.

**Programming: Clear Residency Default**

**Programming: Disable Keypad On Deadbolt**

Default "Time-Out Duration" is automatically set to 10 minutes. This time is the maximum time the "Privacy Feature" is enabled. To set this duration, enter the following sequence with your desired time from 001-250 minutes.

**Programming: Time-Out Duration** [ ] [ ] [ ]

(3 digits)

\*\*\*\*\*

## Privacy Feature Mode 2: (Door Normally Unlocked) Programmable Through Keypad Only; Not DL-Windows

"Privacy Feature Mode 2" is designed to allow access to all and is typically used for rooms needing temporary privacy from others such as bathrooms, dorms and meeting rooms.

Configuring the DL4500 for the "Privacy Feature Mode 2" will initially provide a normally unlocked (passage mode) state. No access code is necessary to enter. Once inside, the user throws the deadbolt and automatically disables the keypad from allowing another user to enter for a pre-programmed amount of time. The red LED on the exterior / outside of the lock will blink indicating that the room is occupied. When the initial user exits, the DL4500 is automatically set back into the original unlocked (passage) mode and the DL4500 will allow new access to all.

The lockout time for the DL4500 can be pre-programmed by the installer. The lockout time can be programmed to disable access code access for up to 250 minutes. All users 12 and higher are disabled when this feature is active. Users 1 - 11 or a key can always override this lockout feature with their codes. **Note:** Function 45 may only be programmed by using the keypad. In addition, Programmed Schedules will override the state of the lock using Functions 45 and 46. If it is required that programmed schedules do not override passage mode, Enable/Disable Passage Mode using Functions 48/49.

**Programming: Clear Residency Default**

**Programming: Disable Keypad On Deadbolt**

**Enable Passage Mode**

Default "Time-Out Duration" is automatically set to 10 minutes. This time is the maximum time the "Privacy Feature" is enabled. To set this duration, enter the following sequence with your desired time from 001-250 minutes.

**Programming: Time-Out Duration** [ ] [ ] [ ]

(3 digits)

# DL4100 Residency and Privacy Features

## Privacy Feature Mode 1: (Door Normally Locked--Factory Default) Programmable Through DL-Windows & Keypad





"Privacy Feature Mode 1" is designed to allow access to individuals with access codes and is typically used for rooms needing privacy from others such as bathrooms, dorms and meeting rooms (Factory Default).

Configuring the DL4100 for the "Privacy Feature Mode 1" will initially provide a normally locked state. To enter through a DL4100 monitored door the user must use an access code or key. Once inside, the user presses the button and automatically disables the keypad from allowing another user to enter for a pre-programmed amount of time. The red LED on the exterior / outside of the lock will blink indicating that the room is occupied. When the initial user exits, the DL4100 is automatically set back into the original locked mode and allows access to any authorized users.

The disable time (lockout) for the DL4100 can be pre-programmed by the installer. The disable time can be programmed to disable access code access for up to 250 minutes. All users 12 and higher are disabled when this feature is active. Users 1 - 11 or a key can always override this lockout feature with their user codes.

**Programming: Disable Keypad On Button Press**       

Default "Time-Out Duration" is automatically set to 10 minutes. This time is the maximum time the "Privacy Feature" is enabled. To set this duration, enter the following sequence with your desired time from 001-250 minutes.

**Programming: Time-Out Duration**     [ \_ \_ \_ ]   
\*\*\*\*\*  
(3 digits)

## Residency Feature:

The "Residency Feature" is provided to prevent a person from unintentionally having the door lock behind them when stepping outside briefly. Typically used in retirement homes and college dormitories.

Configuring the DL4100 for the "Residency Feature" will initially provide a normally locked state. To enter through a DL4100 monitored door the user must use an access code or key. The DL4100 will then re-lock when door is closed.

Turning the handle and exiting from the inside will unlock the DL4100 and set it to passage mode.

Any of the following will restore the lock to the normally secure mode.

1. The user returns, enters, and presses the button from the inside.
2. Someone already inside the premises presses the button.
3. Pre-programmed scheduling.
4. Entering a valid access code or locking with a key.

**Programming: Clear Privacy Default**        

**Programming: Leave Unlocked on Exit (Passage)**       

**Cancel Passage on Button Press**       

## Privacy Feature Mode 2: (Door Normally Unlocked) Programmable Through Keypad Only; Not DL-Windows

"Privacy Feature Mode 2" is designed to allow access to all and is typically used for rooms needing temporary privacy from others such as bathrooms, dorms and meeting rooms.

Configuring the DL4100 for the "Privacy Feature Mode 2" will initially provide a normally unlocked (passage mode) state. No access code is necessary to enter. Once inside, the user presses the button and automatically disables the keypad from allowing another user to enter for a pre-programmed amount of time. The red LED on the exterior / outside of the lock will blink indicating that the room is occupied. When the initial user exits, the DL4100 is automatically set back into the original unlocked (passage) mode and the DL4100 will allow new access to all.

The lockout time for the DL4100 can be pre-programmed by the installer. The lockout time can be programmed to disable access code access for up to 250 minutes. All users 12 and higher are disabled when this feature is active. Users 1 - 11 or a key can always override this lockout feature with their codes. **Note:** Function 45 may only be programmed by using the keypad. In addition, Programmed Schedules will override the state of the lock using Functions 45 and 46. If it is required that programmed schedules do not override passage mode, Enable/Disable Passage Mode using Functions 48/49.

**Programming: Clear Privacy Default**        

**Programming: Disable Keypad On Button Press**       

**Enable Passage Mode**    

Default "Time-Out Duration" is automatically set to 10 minutes. This time is the maximum time the "Privacy Feature" is enabled. To set this duration, enter the following sequence with your desired time from 001-250 minutes.

**Programming: Time-Out Duration**     [ \_ \_ \_ ]   
(3 digits)



# Programming Record Sheet

Default Values are shown in parentheses.

Function Number(s)	Function Name	Programming
41	Daylight Saving Time Code	<input type="text" value=""/> <input type="text" value=""/> 01-24 (1) (2) DST Code
43/44	Clock Adjust	+/- <input type="text" value=""/> <input type="text" value=""/> 0-55 (0) (0) Seconds
52/53/54	Pass Time	(3 sec) <input type="checkbox"/> 10 sec <input type="checkbox"/> 15 sec <input type="checkbox"/>
59	AL-DTM Door Number	<input type="text" value=""/> <input type="text" value=""/> 1-96 (48 for AL-DTM (Version 1)) (0) (1) Door Number
60	Set Lockout Attempts	<input type="text" value=""/> 1-9 Attempts (6)
61	Set Lockout Time	<input type="text" value=""/> <input type="text" value=""/> 1-60 seconds (1) (8)
66	Ambush Code	<input type="text" value=""/> <input type="text" value=""/> 00-99 (9) (9) Ambush Code
67	Add Relay/System Features	<p><b>Check all that apply</b></p> <ul style="list-style-type: none"> <li>3. Failed attempted entry <input type="checkbox"/></li> <li>4. Disabled User or Group <input type="checkbox"/></li> <li>5. Follow Access Granted <input type="checkbox"/></li> <li>6. Group 1 User Code <input type="checkbox"/></li> <li>7. Scheduled Lock Event <input type="checkbox"/></li> <li>8. Scheduled Unlock Event <input type="checkbox"/></li> <li>9. Lock Out <input type="checkbox"/></li> <li>10. Ambush <input type="checkbox"/></li> <li>11. First Key Press <input type="checkbox"/></li> <li>25. Disable Sounder <input type="checkbox"/></li> <li>26. 5 sec. Delayed Entry <input type="checkbox"/></li> <li>27. 15 sec. Delayed Entry <input type="checkbox"/></li> <li>28. 45 sec. Delayed Entry <input type="checkbox"/></li> <li>31. Follow Access Granted--No Time Limit <input type="checkbox"/></li> <li>35. Disable Keypad on Deadbolt <input type="checkbox"/></li> <li>36. Cancel Passage on Deadbolt <input type="checkbox"/></li> <li>37. Leave Unlocked on Exit (Passage) <input type="checkbox"/></li> </ul>
68	Privacy Time-Out Duration	<input type="text" value=""/> <input type="text" value=""/> <input type="text" value=""/> 1-250 minutes (0) (1) (0)
69/70	Enter Key	Enable <input type="checkbox"/> (Disable) <input type="checkbox"/>





# Glossary

**ACCESS** = To allow Users to unlock the door temporarily to gain entry.

**AMBUSH** = A special Code entered at the keypad when the User is forced to unlock a device. The device unlocks but sends a silent alarm with no indication at the keypad. Can be used to trip a relay, to alert security, or trip a silent alarm on a Burglary Control Panel.

**AUDIT TRAIL** = A date/time stamped log of previous lock events.

**BUTTON PRESS** = A button control on the DL4100 series locks preventing access to outside Users.

**BURGLARY CONTROL PANEL** = Provides local alarm and remote communication to request security for burglary/break-in. A DL4500 relay output used for Ambush can provide a silent alarm and call-for-help.

**CANCEL PASSAGE ON DEADBOLT/BUTTON PRESS** = A lock function in the "Residency" Feature that will prevent passage through the door (for Users without a functional User Code) after extending the deadbolt or pressing the button.

## CLOCK

- **REAL TIME CLOCK** = An accurate built-in clock that allows date/time stamping of events. The clock can be slowed or speeded up to fine tune long term accuracy to within three minutes per year.
- **CLOCK SETTINGS** = Printout includes date, time, weekday, and clock speed.
- **CLOCK SPEED** = The clock can be adjusted to allow faster/slower speeds and therefore increasing clock accuracy.

**CODE** = Numeric sequence of numbers (such as: 1234) entered at the keypad. If Star-Enter-Key is required, must be followed by a  key.

- **AMBUSH CODE** = See Ambush.
- **BASIC USER CODE** = User Codes assigned to User Numbers 12+ (except Users 297-300). (Does not allow programming)
- **INSTALLER CODE** = User Codes assigned to User Numbers 2 and 3. (Allows all programming except Master functions).
- **INVALID CODE** = A User Code that has not been programmed in the lock.
- **MANAGER CODE** = User Codes assigned to User Numbers 4 through 6. (Allows most of the programming functions).
- **MASTER CODE** = User Code assigned to User Number 1. Default (factory) Master Code is 123456. The User with the Master Code has complete control of the lock.
- **PRINT ONLY USER CODE** = User Code assigned to Users 10 and 11. (Allows no programming except print functions).
- **QUICK ENABLE USER 300 CODE** = Refers to the User Code entered by User 297 which (when entered at the keypad) enables the User Code assigned to User 300 for one time only.
- **QUICK PC ACCESS CODE** = Permits upload/download to DL-Windows Software on IBM/compatible (300 MHz or faster)

computer running Microsoft Windows 98, or NT 4.0 (or higher). Refers to the User Code for User 298.

- **SERVICE CODE** = User 300 User Code. Allows only one entry, then needs to be re-enabled by the User 297 User Code to regain access.
- **SUPERVISOR CODE** = User Codes assigned to Users 7, 8 and 9. Can only program day-to-day operation.
- **USER CODE** = Code used by Users. Code is 3 to 6 numeric digits long, allowing controlled entry.
- **VALID CODE** = An entered User Code that has been programmed in the device.

**COM PORT** = A computer serial communications port used to communicate with the Lock and/or Data Transfer Module.

**DATA TRANSFER MODULE** = A device that permits transfer of program/data between a computer and the lock.

**DATE** = Month, Day and Year entered as MMDDYY.

**DAY OF WEEK** = Sunday through Saturday (where 1 = Sunday and 7 = Saturday).

**DEFAULT** = Default settings are the original settings that were set at the factory; in other words, it is the lock's original factory condition when the lock was first taken out of its box. The default settings are permanently encoded within the lock's fixed memory, and when the lock is first started, or when power is removed and re-applied (see Wiring and Power-Up, page 11), the original factory default settings are re-loaded and take effect.

**DISABLE** = Turn off.

**DISABLE KEYPAD ON DEADBOLT / BUTTON PRESS** = A feature of the "Privacy" feature that disables the keypad (except for User Numbers 1-11) when the deadbolt is extended or the button is pressed.

**DOOR NUMBER** = Identification of each door with a specific number (1-96). (Used with AL-DTM2 Transfer Module)

**DOWNLOAD** = Send data to lock or AL-DTM.

**ENABLE** = Turn on.

**EVENTS** = Recorded lock activity.

**FACTORY DEFAULT** = See Default.

**FUNCTION** (also called **Programming Functions**) = are the numbers used to program lock features (enabling/disabling Users, User Groups, Passage Mode, Schedules, etc.).

## GROUP

- **USER GROUP** = Defining a User to specific Groups, allows User entry when the Group is allowed entry.
- **GROUP 1 DISARMS BURGLAR CONTROL** = A Group 1 USER CODE entry can disarm an alarm panel during a predefined schedule. Should the Group 1 enter the lock outside of the scheduled time, the alarm will not disarm. The alarm panel must be armed through other means (such as an Alarm Panel Keypad). The Burglary Alarm Panel must be programmed to disarm from an Armed State Only and the zone input must be programmed for input disarming.



# Glossary (cont'd)

- **GROUP 1 ENABLES GROUP 4 USERS** = A Group 1 USER CODE entry during a predefined schedule will allow access to Group 4 Users.
- **GROUP 1 PUTS UNIT IN PASSAGE** = A Group 1 USER CODE entry during a pre-defined schedule will unlock unit.

**HANDLE PRESS** = An clockwise or counter-clockwise movement of the handle.

- **INSIDE HANDLE** - The handle on the back (non-keypad side) of the lock.
- **OUTSIDE HANDLE** - The handle on the front (keypad side) of the lock.

**INSTALLER** = See.... CODE, INSTALLER CODE.

**KEYPAD** = 10-numeric keys,  and special  key.

- **KEYPAD LOCKOUT** = Keypad is programmed to lockout Users, for a specified period of time, when a specified number of invalid User Codes are entered.
- **KEYPAD PROGRAMMING** = Ability to program the lock through the keypad.

**KEYPRESS** = Pressing a button on the Lock's Keypad.

**LEAVE UNLOCK ON EXIT (PASSAGE)** - A feature in "Residency" Mode allowing free access (Passage Mode) when the lock handle is turned.

**LEVEL ABILITY** = Predefined User Types (such as Master, Installer, Manager, Supervisor, and Print Only User) have specific abilities to program and/or control the lock.

**LOCKOUT ATTEMPTS** = A specified number of invalid User Code entries (1-9), that will disable the keypad for a predefined period of time (1-60 seconds).

**LOCKOUT TIME** = A predefined time (1-60) seconds that the lock will stop accepting User Codes, after a specified number of invalid User Code entries (1-9).

**LOG** = See... AUDIT TRAIL.

**MANAGER** = See... CODE, MANAGER CODE.

**MASTER** = See... CODE, MASTER CODE.

**PASSAGE** = Allow anyone to pass through the door without USER CODES (door is unlocked).

**PRINTER** = A printout device such as an infrared printer or computer printer.

**PRIVACY** = A lock mode for privacy from other Users.

- **Time-out Duration** = A maximum period of time that the User is allowed privacy before other Users are allowed entry.
- **Door Normally Locked (Mode 1)** = User Code initially required for entry; "Privacy" feature enabled once inside.
- **Door Normally Unlocked (Mode 2)** = All Users allowed for initial entry; "Privacy" feature enabled once inside.

**PROGRAM MODE** = A mode allowing program/data to be entered through the keypad. Only specific Users can program a lock

manually, by entering their USER CODE, followed by the  key. To exit program mode, hold any key until repeated beeps are heard.

**PROGRAMMABLE RELAY FUNCTIONS** = The relay can be programmed for one or more functions.

**RELAY** = Switched output allowing remote control of other devices. For an explanation of all relay features, see Function 67 on page 24.

**RESIDENCY** = The lock default for the DL4500 which prevents unintentional door lock after briefly stepping outside.

**SCHEDULE** = A programmed operation (enable/disable, lock/unlock, etc.) on a specific day (Sunday through Saturday) and time.

**SCHEDULES, QUICK** = Any one of four most common types of schedules can be programmed.

**TIME** = Hours and Minutes in the HHMM format.

**TIME/DATE STAMP** = A recorded date and time that an event occurred.

**TIMEOUT** = Immediate operation for a specified number of hours.

**UPLOAD** = Receive data from the lock or AL-DTM.

**USER** = A person who has been provided with a USER CODE for access through the door.

**USER LOCKOUT, TOTAL** = All Users (except for Master Code) have been locked out.

# NOTES

# NOTES

## **ALARM LOCK LIMITED WARRANTY**

ALARM LOCK SYSTEMS, INC. (ALARM LOCK) warrants its products to be free from manufacturing defects in materials and workmanship for 24 months following the date of manufacture. ALARM LOCK will, within said period, at its option, repair or replace any product failing to operate correctly without charge to the original purchaser or user.

This warranty shall not apply to any equipment, or any part thereof, which has been repaired by others, improperly installed, improperly used, abused, altered, damaged, subjected to acts of God, or on which any serial numbers have been altered, defaced or removed. Seller will not be responsible for any dismantling or reinstallation charges.

THERE ARE NO WARRANTIES, EXPRESS OR IMPLIED, WHICH EXTEND BEYOND THE DESCRIPTION ON THE FACE HEREOF. THERE IS NO EXPRESS OR IMPLIED WARRANTY OF MERCHANTABILITY OR A WARRANTY OF FITNESS FOR A PARTICULAR PURPOSE. ADDITIONALLY, THIS WARRANTY IS IN LIEU OF ALL OTHER OBLIGATIONS OR LIABILITIES ON THE PART OF ALARM LOCK.

Any action for breach of warranty, including but not limited to any implied warranty of merchantability, must be brought within the six months following the end of the warranty period. IN NO CASE SHALL ALARM LOCK BE LIABLE TO ANYONE FOR ANY CONSEQUENTIAL OR INCIDENTAL DAMAGES FOR BREACH OF THIS OR ANY OTHER WARRANTY, EXPRESS OR IMPLIED, EVEN IF THE LOSS OR DAMAGE IS CAUSED BY THE SELLER'S OWN NEGLIGENCE OR FAULT.

In case of defect, contact the security professional who installed and maintains your security system. In order to exercise the warranty, the product must be returned by the security professional, shipping costs prepaid and insured to ALARM LOCK. After repair or replacement, ALARM LOCK assumes the cost of returning products under warranty. ALARM LOCK shall have no obligation under this warranty, or otherwise, if the product has been repaired by others, improperly installed, improperly used, abused, altered, damaged, subjected to accident, nuisance, flood, fire or acts of God, or on which any serial numbers have been altered, defaced or removed. ALARM LOCK will not be responsible for any dismantling, reassembly or reinstallation charges.

This warranty contains the entire warranty. It is the sole warranty and any prior agreements or representations, whether oral or written, are either merged herein or are expressly canceled. ALARM LOCK neither assumes, nor authorizes any other person purporting to act on its behalf to modify, to change, or to assume for it, any other warranty or liability concerning its products.

In no event shall ALARM LOCK be liable for an amount in excess of ALARM LOCK's original selling price of the product, for any loss or damage, whether direct, indirect, incidental, consequential, or otherwise arising out of any failure of the product. Seller's warranty, as hereinabove set forth, shall not be enlarged, diminished or affected by and no obligation or liability shall arise or grow out of Seller's rendering of technical advice or service in connection with Buyer's order of the goods furnished hereunder.

ALARM LOCK RECOMMENDS THAT THE ENTIRE SYSTEM BE COMPLETELY TESTED WEEKLY.

Warning: Despite frequent testing, and due to, but not limited to, any or all of the following; criminal tampering, electrical or communications disruption, it is possible for the system to fail to perform as expected. ALARM LOCK does not represent that the product/system may not be compromised or circumvented; or that the product or system will prevent any personal injury or property loss by burglary, robbery, fire or otherwise; nor that the product or system will in all cases provide adequate warning or protection. A properly installed and maintained alarm may only reduce risk of burglary, robbery, fire or otherwise but it is not insurance or a guarantee that these events will not occur. CONSEQUENTLY, SELLER SHALL HAVE NO LIABILITY FOR ANY PERSONAL INJURY, PROPERTY DAMAGE, OR OTHER LOSS BASED ON A CLAIM THE PRODUCT FAILED TO GIVE WARNING. Therefore, the installer should in turn advise the consumer to take any and all precautions for his or her safety including, but not limited to, fleeing the premises and allege police or fire department, in order to mitigate the possibilities of harm and/or damage.

ALARM LOCK is not an insurer of either the property or safety of the user's family or employees, and limits its liability for any loss or damage including incidental or consequential damages to ALARM LOCK's original selling price of the product regardless of the cause of such loss or damage.

Some states do not allow limitations on how long an implied warranty lasts or do not allow the exclusion or limitation of incidental or consequential damages, or differentiate in their treatment of limitations of liability for ordinary or gross negligence, so the above limitations or exclusions may not apply to you. This Warranty gives you specific legal rights and you may also have other rights which vary from state to state.